



# • 600'54 Ascend

User Manual

Version 02



Copyright © by Bruker Corporation

All rights reserved. No part of this publication may be reproduced, stored in a retrieval system, or transmitted, in any form, or by any means without the prior consent of the publisher. Product names used are trademarks or registered trademarks of their respective holders.

This manual was written by

Peter van Bommel

© September 2012: Bruker Corporation

Faellanden, Switzerland

ZTKS0181 / Z31956 / Rev.: 02

For further technical assistance on the NMR magnet system, please do not hesitate to contact your nearest BRUKER dealer or contact us directly at:

BRUKER Corporation  
Industriestrasse 26  
CH - 8117 Faellanden  
Switzerland

Phone: + 41 44 825 91 11  
Fax: + 41 44 825 96 96  
E-mail: [service@bruker.ch](mailto:service@bruker.ch)  
Internet: [www.bruker.com](http://www.bruker.com)

---

<b>0</b>	<b>Contact .....</b>	<b>9</b>
<b>1</b>	<b>Introduction.....</b>	<b>11</b>
<b>2</b>	<b>Safety .....</b>	<b>13</b>
<b>3</b>	<b>Transportation .....</b>	<b>29</b>
<b>4</b>	<b>Assembling .....</b>	<b>35</b>
<b>5</b>	<b>Operation.....</b>	<b>37</b>
<b>6</b>	<b>Troubleshooting .....</b>	<b>39</b>
<b>7</b>	<b>Maintenance.....</b>	<b>55</b>
<b>8</b>	<b>Disassembling .....</b>	<b>57</b>
<b>A</b>	<b>Appendix .....</b>	<b>59</b>



<b>0</b>	<b>Contact .....</b>	<b>9</b>
<b>1</b>	<b>Introduction.....</b>	<b>11</b>
1.1	General Information.....	11
1.2	Limitation of Liability .....	11
1.3	Customer Service.....	11
1.4	Warranty.....	11
1.5	Copyright.....	11
1.6	General View.....	12
<b>2</b>	<b>Safety.....</b>	<b>13</b>
2.1	Approved Persons.....	13
2.2	Customer Responsibilities.....	14
2.3	Key Words.....	15
2.4	Residual Risks.....	16
2.4.1	Persons .....	16
2.4.2	Intended Use .....	16
2.4.3	Safety Devices .....	17
2.4.4	Spare Parts .....	17
2.4.5	Signs and Labels.....	18
2.4.6	Technical Risks .....	18
2.5	Personal Protective Equipment.....	24
2.6	Description of Signs and Labels.....	25
2.7	Safety Devices .....	26
2.8	Behavior in Danger and Emergency Situations.....	28
2.9	Fire Department Notification.....	28
<b>3</b>	<b>Transportation .....</b>	<b>29</b>
3.1	Safety .....	29
3.2	Packaging.....	29
3.2.1	Disposal.....	30
3.3	Transport Inspection.....	30
3.4	Transportation by Fork Lift / Pallet Jack.....	31
3.5	Transportation with a Crane .....	32
3.6	Storing .....	33
3.7	Disposal.....	33
<b>4</b>	<b>Assembling .....</b>	<b>35</b>
4.1	Safety .....	35

# Table of Contents

<b>5</b>	<b>Operation.....</b>	<b>37</b>
5.1	Safety .....	37
5.2	Set into Operation.....	38
<b>6</b>	<b>Troubleshooting .....</b>	<b>39</b>
6.1	Safety .....	39
6.2	Problem .....	40
6.2.1	During Transportation.....	40
6.2.2	During Assembling .....	40
6.2.3	During Cooling Down.....	42
6.2.4	During Energizing and Shimming.....	46
6.2.5	During Operation of the Magnet Stand.....	48
6.2.6	During Standard Operation.....	50
6.2.7	During De-energizing and Warming up .....	52
6.3	Troubleshooting Work .....	53
6.3.1	After a Quench .....	53
<b>7</b>	<b>Maintenance.....</b>	<b>55</b>
7.1	Safety .....	55
7.2	Cleaning .....	56
7.3	Maintenance Timetable .....	56
<b>8</b>	<b>Disassembling .....</b>	<b>57</b>
8.1	Safety .....	57
<b>A</b>	<b>Appendix .....</b>	<b>59</b>
A.1	Warning Signs .....	61
A.2	Figures.....	63
A.3	Tables.....	65
A.4	Glossary / Abbreviations.....	67
A.5	Technical Data MS 600'54 Ascend .....	69
A.6	Index.....	99





# 0 Contact

## **Manufacturer**

Bruker BioSpin AG

Industriestrasse 26

CH-8117 Faellanden

Switzerland

Phone: + 41 44 825 91 11

Fax: + 41 44 825 96 96

<http://www.bruker.com>

E-mail: [service@bruker.ch](mailto:service@bruker.ch)

Please refer to the Model No., Serial No. and Internal Order No. in all correspondence regarding the NMR system or components thereof.



# 1 Introduction

## 1.1 General Information

---

This manual contains important information about the handling of the supplied magnet system used for NMR spectroscopy and its components. The compliance with all safety and handling instructions, the applicable local accident prevention and general safety regulations are necessary for safe work.

This manual is part of the product. It must be kept nearby the magnet system and free access must be ensured at any time. Read the manual carefully before handling the magnet system or its components.

## 1.2 Limitation of Liability

---

The information in this manual will take into account the current state of the technology.

The manufacturer assumes no liability for damages resulting from:

- non-compliance with the instructions and all applicable documentation,
- use for purposes not intended,
- not sufficiently approved persons,
- arbitrary changes or modifications and
- use of not approved spare parts or accessories.

## 1.3 Customer Service

---

Technical support is provided by Bruker Service via telephone or e-mail. For contact information see page 9 of this document.

## 1.4 Warranty

---

The warranty terms can be found in the sales documents of the magnet system and in the Terms and Conditions of Bruker BioSpin AG.

## 1.5 Copyright

---

No part of this publication may be reproduced, stored in a retrieval system, or transmitted, in any form or by any means without the prior consent of the publisher. Product names used are trademarks or registered trademarks of their respective holders.

## 1.6 General View

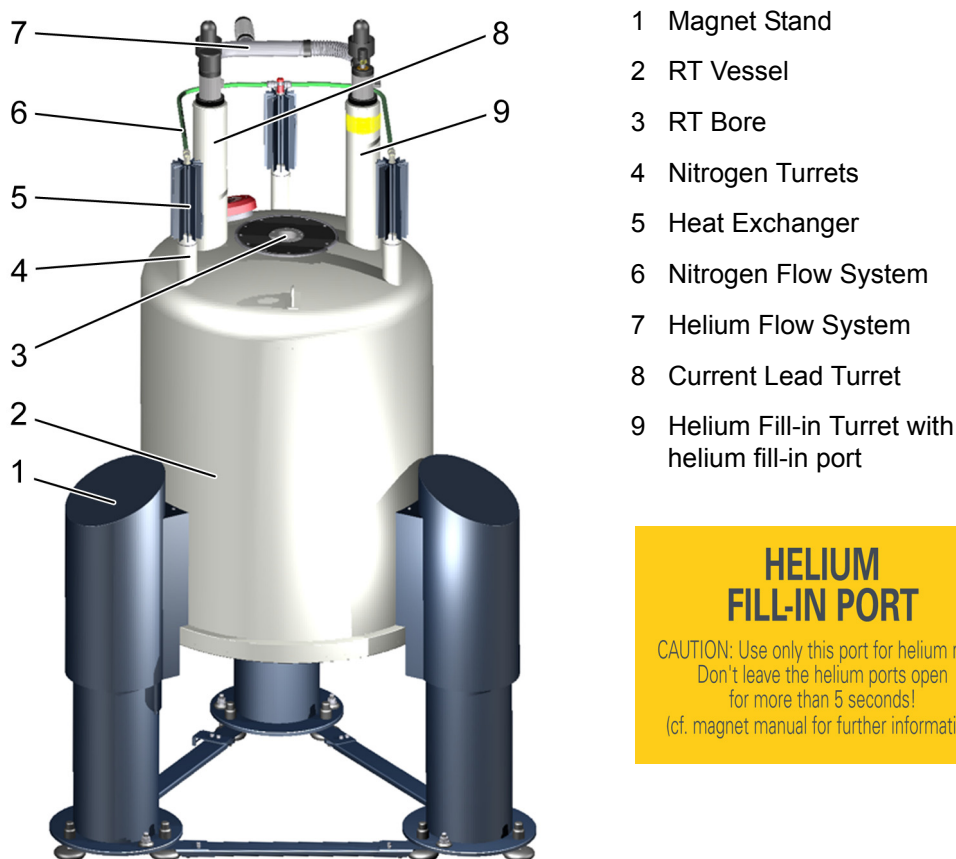

Figure 1.1: General View of a Magnet System with 2 Helium Turrets

The heart of the NMR magnet system is a superconducting magnet located inside the helium vessel, which is filled with liquid helium. The helium vessel is surrounded by a nitrogen vessel filled with liquid nitrogen. The outer casing, the room temperature (RT) vessel (2), contains the helium vessel and the nitrogen vessel. The vacuum in the RT vessel reduces thermal conduction. The RT bore (3) allows the access to the magnetic center. RT vessel, inner vessels, turrets, flow systems and the RT bore together build the cryostat of the magnet system.

The cryostat is mounted on a magnet stand (1). The isolators in the magnet stand absorb floor vibrations. Different heights and isolators are available optionally.

The nitrogen turrets (4) connected with the nitrogen flow system (6) and the heat exchangers (5) are the interface to the nitrogen vessel. The nitrogen fill-in turret is marked with a green label.

The helium turrets (8, 9) connected with the helium flow system (7) are the interface of the helium vessel and the magnet coil. The helium fill-in turret (9) is marked with a yellow label.

The current lead turret (8) is the interface for energizing the magnet coil and for diagnostic.

## 2 Safety

The supplied cryostat and further equipment of the magnet system were designed and manufactured according to best available technical knowledge and practice, achieved in over 50 years of experience of the Bruker Corporation. International standards for quality and approval recommended for cryostats of superconducting magnets were certified.

Nevertheless non-compliance with the following instructions and safety advice may cause serious hazards and property damage.

### 2.1 Approved Persons

---

Bruker BioSpin AG identifies the following qualifications for personnel performing tasks on the magnet system or its components:

#### **Approved Customer Personnel**

As a result of professional training by Bruker Service Personnel, experience and knowledge of applicable regulations these persons are qualified to perform the specific tasks on the magnet system and its components assigned to them in this manual. Approved Customer Personnel are qualified to identify possible hazards and risks associated with the tasks assigned to them and to perform all possible steps to eliminate or minimize these risks.

#### **Bruker Service Personnel**

These persons are qualified by appropriate qualification and professional training and experience (including all necessary knowledge of applicable regulations and regulatory requirements) to perform specific tasks on the magnet system and its components. Bruker Service Personnel are qualified to identify possible hazards and risks and to perform all possible steps to eliminate or minimize these risks.

## 2.2 Customer Responsibilities

---

The customer must obey the security advice and the rules for safety, applicable local accident prevention and environmental protection correctly for the magnet system. Furthermore, the customer is responsible for keeping the magnet system in good technical condition.

### In particular:

- The customer must identify additional dangers resulting from the working conditions at the site of the magnet system and provide applicable safety measures.
- The customer must ensure that the site plan meets the specified conditions according to the site planning document for operating the magnet system.
- The customer must clearly mark the danger area around the magnet system and post the corresponding instruction plates.
- The customer has to ensure the intended use of the magnet system.
- The customer has to inform the local fire brigade about the special risks of the magnet system and how to react in the event of an incident.
- The customer must clearly define the responsibilities for operation and maintenance.
- The customer must ensure that all employees working with the magnet system have read and understood the manual.
- The customer has to provide the necessary personal protective equipment for his employees.
- The customer has to instruct his employees at regular intervals on hazards and safety measures.
- The customer has to instruct other persons not working on the magnet system but carrying out work in the same room, for instance cleaning staff or guards about the possible danger at the site of the magnet system.
- The customer must ensure that maintenance is performed according to the schedule listed in chapter "**Maintenance Timetable**" on page 56.

## 2.3 Key Words

---



### **DANGER**

Indicates a hazardous situation which, if not prevented, will result in death or serious injury.



### **WARNING**

Indicates a hazardous situation which, if not prevented, could result in death or serious injury.



### **CAUTION**

Indicates a hazardous situation which, if not prevented, may result in moderate or minor injury.

### **NOTICE**

Hazard, which could result in property damage.



Information and links for efficient and trouble-free handling and operation.

---

## 2.4 Residual Risks

---

In the following chapter the residual risks from the risk analysis according ISO 14971 are summarized. To prevent health hazards and hazardous situations obey all safety instructions and warnings in the manual.

### 2.4.1 Persons

---

#### **WARNING**



#### **Risk of injury and property damage due to handling by not approved persons.**

Incorrect handling of the magnet system by not approved persons may result in significant bodily injury and property damage.

Thus:

- Work must only be carried out by approved persons with applicable qualifications. The necessary qualifications are specified in the beginning of the relevant chapter.
- In case of doubt, contact Bruker Service. Contact information see page 9 of this document.

### 2.4.2 Intended Use

---

The supplied magnet system is designed and intended for NMR spectroscopy only.

#### **WARNING**



#### **Risk of damage to life and limb by incorrect use of the magnet system.**

Incorrect use of the magnet system can lead to life-threatening situations and destruction of the magnet system.

Thus:

- Only use the magnet system as intended.
- Do not change the magnet system.
- Do not exceed specified values for operating the magnet system.
- Do not use inserts inside the RT bore not approved by Bruker Service.

Damage claims from damages caused by other than the intended use of the magnet system are excluded and the customer is held liable.

### 2.4.3 Safety Devices

---

#### WARNING



##### **Risk of damage to life and limb due to not sufficient safety devices.**

Several safety devices ensure safe operation of the magnet system. They must always be in correct working condition.

Thus:

- Do not block safety devices.
- Do not remove safety devices.
- Check the operational reliability of the safety devices before working on the magnet system.

### 2.4.4 Spare Parts

---

#### WARNING



##### **Risk of injury and property damage from using incorrect or defective spare parts and accessories.**

Incorrect or defective spare parts can cause serious injuries. They may cause damaging, malfunctioning and the destruction of the magnet system.

Thus:

- Only use original equipment manufacturer spare parts.
- Only use original equipment manufacturer accessories.

## 2.4.5 Signs and Labels

---



### **WARNING**

#### **Risk of damage to persons and property due to not readable signs and labels.**

Signs and labels with advice may become not readable.

Thus:

- Maintain signs and labels in a readable state.
- Replace damaged or not readable signs and labels immediately. New signs and labels can be ordered from Bruker Service.

## 2.4.6 Technical Risks

---

### Magnetic Field



### **WARNING**

#### **Risk of damage to life and limb due to high magnetic fields.**

A magnetic field of more than 0.5 mT (5 Gauss) is life-threatening for people with pacemakers or active metal implants. Exposure to more than 8 T can cause damage to health. Duration of exposure (8 h/day) above the limit of 200 mT can cause damage to health. Ferromagnetic tools in the magnetic field are significantly hazardous. Disks and electronic devices may be damaged.

Thus:

- Mark the magnetic field of more than 0.5 mT (5 Gauss) before start up.
- Keep people with active medical implants away from the 0.5 mT (5 Gauss) area.
- The permanent workplace of employees must be outside the 0.5 mT (5 Gauss) area.
- Do not stay or work at magnetic fields of more than 8 T.
- Prevent exposure of more than 200 mT for more than 8 h/day.
- Keep disks, credit cards and electronic devices away from the identified area.
- Do not use ferromagnetic tools or items within the identified area.
- Only use non-ferromagnetic transportation dewars or pressure cylinders for the cryogenic agents.
- Only use non-ferromagnetic ladders or steps.

## Cryogenic Agents

### WARNING



#### **Risk of damage to life and limb due to cryogenic agents.**

Risk of damage to life and limb due to not correct handling of liquid cryogenic agents. Within the transition from liquid to gas, helium and nitrogen expand their volume, causing closed vessels or transportation dewars to burst. The evaporating cryogenic agents will displace the breathing air. Helium displaces the breathing air in the upper part of the room, nitrogen displaces the breathing air in the lower parts of the room. In case of not sufficient ventilation this may result in death by suffocation.

Liquid and gaseous cryogenic agents are extremely cold. Contact with liquid or gaseous cryogenic agents will lead to cold burns. Contact with the eyes may cause blindness. Refer to Warning: Low Temperature on page 21.

Thus:

- Only use cryogenic agents in well ventilated rooms. In case of doubt ask Bruker Service.
- Wear an oxygen monitor on the body during service and maintenance work.
- Prevent any skin contact with liquid or gaseous cryogenic agents.

## Electricity

### WARNING



#### **Risk of damage to life and limb due to electricity.**

Risk of damage to life and limb due to contact with electrical lines and damaged insulation.

Thus:

- Work on electrical equipment must be done by an approved electrical technician.
- Keep moisture away from electrical lines to prevent short-circuits.
- Check the magnet system electrical grounding before start.
- Switch the power OFF before working on the Bruker Power Supply or further equipment.

## Quench



### **WARNING**

#### **Risk of suffocation during a quench of the magnet system.**

A quench is the very fast de-energizing of the magnet by loss of its superconductivity. The stored magnetic energy is converted into heat and thus large quantities of helium evaporate. The evaporating helium will displace the breathing air. In case of not sufficient ventilation this may result in death by suffocation.

Thus

- The magnet system site must be well ventilated. In case of doubt contact Bruker Service.
- The evaporating gas may resemble smoke. Never pour water on the magnet system.

## Gas under Pressure



### **WARNING**

#### **Risk of injury due to gas under pressure inside the cryostat and further equipment.**

The helium or the nitrogen vessel of the cryostat may get sealed off due to ice formation inside the helium or the nitrogen turrets in case of non-compliance with the instruction given in this manual. This may lead to overpressure and damage of the helium or the nitrogen vessel.

Manipulations of components with gas under pressure may lead to injury and property damage.

Thus:

- In case of icing inside the helium or the nitrogen turrets contact Bruker Service immediately.
- Release the pressure to the recommended value before working on components with gases under pressure.
- Do not seal cryogenic agent vessels of the magnet system or the transportation dewars.
- Do not connect high pressure transportation dewars to the magnet system. Completely eliminate the high pressure from the transportation dewars before connecting and transferring cryogenic agents.

### Low Temperatures

#### WARNING



##### **Risk of injury due to low temperatures of liquids and metal parts.**

Physical contact with extremely cold liquids and metal parts may cause serious injuries. Contact with the skin may cause cold burns. Contact with the eyes may cause blindness.

Thus:

- Always wear protective goggles, protective gloves and protective clothes while handling with liquid cryogenic agents or metal parts in contact with liquid cryogenic agents.
- Protect temperature sensitive components such as O-rings from contact with liquid cryogenic agents.

### Spontaneous Ignition and Explosion

#### WARNING



##### **Risk of injury from spontaneous ignition and explosion caused by liquid oxygen.**

Pure oxygen condenses on extremely cold metal pieces. Together with oil it may ignite spontaneously. In case of fire the pure oxygen may cause an explosion.

Thus:

- Do not smoke near the magnet system.
- Do not use open flames near the magnet system.
- Keep the environment around the magnet system clean.
- Do not leave oily rags near the magnet system.

### Risk of Slippage

#### WARNING



##### **Risk of injury from slippage.**

The accumulation of condensed water on the floor and ladders causes slippery surfaces.

Thus:

- Always wear safety shoes with an anti-slip sole.
- Be careful using ladders.
- Clean floor and ladders regularly.

## Risk of Tilting



### **WARNING**

#### **Risk of injury due to tilting of the magnet system.**

The magnet system is very sensitive to lateral forces. It may tilt.

Thus:

- Do not climb onto the magnet system.
- Do not lean items against the magnet system.
- Do not lean against the magnet system.
- Do not move the magnet system on your own.

## Heavy Weights



### **WARNING**

#### **Risk of damage to life and limb caused from heavy weights.**

Lifting heavy weights is life-threatening due to falling or moving parts.

Thus:

- Do not stay or work under a lifted magnet system.
- All lifting equipment in use must be approved to carry the weight.
- Do not use damaged lifting equipment.
- Do not use lifting equipment without updated check tag.
- Lifting only with approved qualification.
- Obey ergonomic guidelines while lifting heavy parts.
- Protect parts against falling.
- Always wear safety shoes with approved toe caps.

## Transportation

### CAUTION

#### **Risk of injury and property damage due to incorrect transportation.**

The boxes may tilt, movement may get out of control. Thus persons may get injured and the cryostat or further equipment may be damaged.

Thus:

- Be careful while unloading and moving the boxes.
- Do not move the boxes arbitrarily.
- Pay attention to all symbols on the boxes.
- Pay attention to sharp edges and spikes of boxes and parts by using protective gloves while moving.
- Move the boxes in an upright position.
- Do not tilt the boxes.
- Prevent crossing thresholds, even if they are only a few millimeters high.
- Clean the transportation way before moving the box.
- Unpack shortly before assembling.
- The cryostat or further equipment must be protected from rain and other bad weather conditions during transportation.
- Exclusively move the cryostat in its original box.
- Do not remove the tightening straps inside the box until assembling.
- Only use the provided attachment points.
- Ensure that the cryostat is always leveled during any transportation.
- Transportation only with attached transportation locks.
- Do not move the evacuated cryostat.
- Do not move the cryostat after cool down.



## 2.5 Personal Protective Equipment

---

The personal protective equipment must be worn at any time while working on the magnet system and further equipment to prevent health hazards.



### **Protective Goggles**

Used to protect the eyes from injury due to flying cold liquids and parts.



### **Protective Gloves**

Used to protect the hands from injury caused by contact with extremely cold liquids or surfaces and for protection from injury caused by rough edges.



### **Protective Clothes**

Used to protect the body from injury caused by contact with extremely cold liquids or surfaces and for protection from wounds.



### **Safety Shoes**

Used to protect the feet from injury from falling of heavy objects. An anti-slip sole protects from injury caused by slipping and falling on slippery floor and steps. Only use safety shoes with non-ferromagnetic toe caps.



### **Portable Oxygen Monitor and Alarm**

Used to warn against low oxygen concentrations in surrounding air.

## 2.6 Description of Signs and Labels

---

Signs and labels are always related to their immediately vicinity. The following signs and labels are found on the magnet system and in the vicinity.



**Prohibition sign: No person with pacemakers!**

People with pacemakers are endangered in the identified area of 0.5 mT (5 Gauss) and are not allowed to enter these areas.



**Prohibition sign: No person with implants!**

People with metallic implants are endangered in the identified area of 0.5 mT (5 Gauss) and are not allowed to enter these areas.



**Prohibition sign: No watches or electronic devices!**

Watches and electronic devices may be damaged in the identified area of 0.5 mT (5 Gauss).



**Prohibition sign: No credit cards or other magnetic memory!**

Credit cards and magnetic memory may be damaged in the identified area of 0.5 mT (5 Gauss).



**Prohibition sign: Do not touch! Do not block!**

Do not touch or block the identified area.



**Hazard warning sign: Strong magnetic field!**

- No magnetic memory.
- No jewelry.
- No metallic items.



**Emergency exit!**

- Always keep the emergency exit clear.
- Follow the arrows if necessary.
- Doors must pushed open in escape direction.

## 2.7 Safety Devices

The supplied cryostat of the magnet system is equipped with the following safety devices:

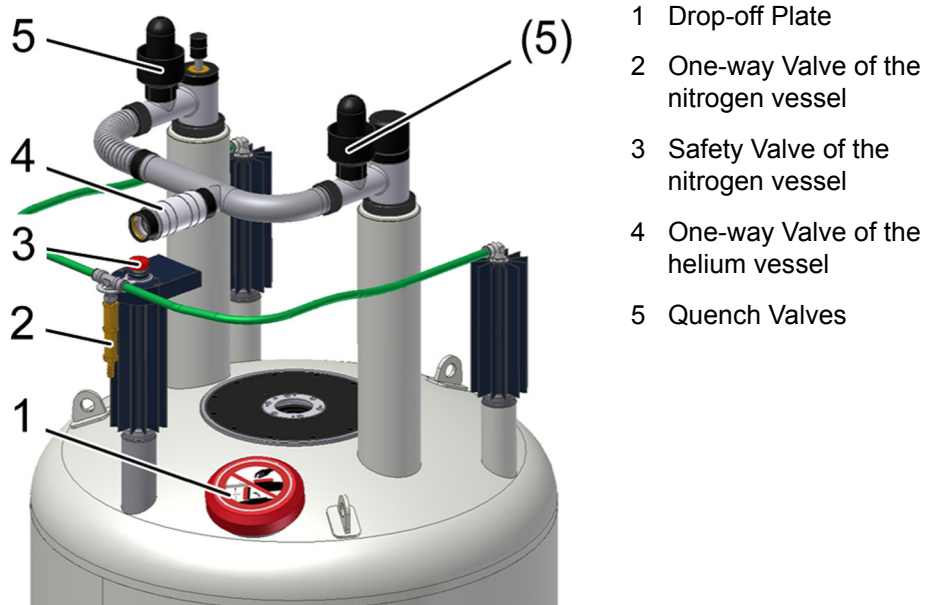

Figure 2.1: Safety Devices of the Cryostat with 2 Helium Turrets

## **Quench Valve**

The quench valves (5) are the safety devices of the helium vessel. They open with a defined pressure. In case of an accidental overpressure in the helium vessel the quench valves will release the pressure smoothly.

## **Safety Valve**

The safety valve (3) is the safety device of the nitrogen vessel. It opens with a defined pressure. In case of an accidental overpressure in the nitrogen vessel the safety valve will release the pressure smoothly.

## **Drop-off Plate**

The drop-off plate (1) is a safety device of the RT vessel. If the vacuum breaks, the drop-off plate will open. In case of an accidental overpressure in the RT vessel the drop-off plate will release the pressure smoothly.

## **One-way Valves**

The one-way valves of the nitrogen flow system (2) and the helium flow system (4) keep air and moisture from entering the helium or the nitrogen vessel in case of an accidental underpressure inside the vessels.

## 2.8 Behavior in Danger and Emergency Situations

---

### Preparations

- Keep the emergency exits free at all times.
- Prepare and maintain an up-to-date list of emergency telephone numbers in the magnet system area.

### In Case of Emergency

- Leave the danger zone immediately.
- Check for sufficient ventilation in the room before entering, especially if people are showing symptoms of suffocation.
- Rescue persons from the danger zone.
- Provide medical attention for people with symptoms of suffocation.
- Start first aid immediately.
- Call the responsible contact.
- Call for medical assistance.
- Call the fire department.

### First Aid for Cold Burns

- Help the injured persons to lie down comfortably in a warm room.
- Loosen all clothing which could prevent blood circulation in the injured area.
- Pour large quantities of warm water over the affected parts.
- Cover the wound with dry and sterile gauze.
- In case of contact of liquid cryogenic agents with the eyes rinse thoroughly with clean water.
- Call for medical assistance.

## 2.9 Fire Department Notification

---

- Inform the fire department about the technical risks of a magnet system, like danger due to ferromagnetic rescue equipment near the magnet system.
- Laboratory windows which are accessible during an emergency should be clearly identified with warning signs, visible from the outside.
- Inform the fire department about the characteristics of a quench to prevent confusion with smoke.
- Never pour water over the magnet system during a quench!

# 3 Transportation

## 3.1 Safety

---

The transportation is carried out by Bruker Service or approved persons. However, it may happen that other persons have to receive the delivery of the shipping boxes. In this case it is essential to obey the instructions in this chapter and to inform these persons before.



### ⚠ WARNING

**Heavy Weights** (see [page 22](#))



### ⚠ CAUTION

**Transportation** (see [page 23](#))

## 3.2 Packaging

---



The cryostat is supplied in a wooden box on a pallet. It is secured inside with straps against tilting and moving.

Accessories such as the flow systems, level sensors and bore tubes are in the side compartment of the box.

The Magnet Stand is supplied in a wooden box on a pallet.

Figure 3.1: Packaging (without surrounding panels)

## 3.2.1 Disposal

---

Keep the original boxes for future transportation.

If no further transportation is planned, dispose of the boxes according to environmentally friendly regulations.

## 3.3 Transport Inspection

---

Investigate the delivery with regard to visible damage and completeness of delivery.

### Transport control systems

The shipping and handling monitors (“Shock Watch“, “Tilt Watch“) on the boxes show if the boxes were kicked or tilted during transportation.

### Checks

Shock Watch: Follow instructions on the label.

Tilt Watch: Follow instructions on the label.

### In case of damage

- Accept delivery with reservation.
- Make a documentation of all observable damage and add it to the transportation documents.
- Start complaint process.
- Contact Bruker Service before installation.

---

**i** The claim for damage expires after the fixed period.

Thus:

Report damages to Bruker Service immediately after detection of damage. For contact information see page 9 of this document.

---

## 3.4 Transportation by Fork Lift / Pallet Jack

A fork lift is recommended for transporting the boxes to the installation site.

**Approved Persons:** Approved forklift / pallet jack operator

**Precondition:** The fork lift / pallet jack must be approved for the transportation weight (refer to the supplied Sales Information).

### Transport



Figure 3.2: Transportation by Forklift - front side

1. Check the route of transport for the minimal height and width.
2. Check sufficient floor capacity on the route of transport. In case of doubt ask a stress analyst.
3. Check sufficient carrying capacity while using an elevator.
4. Position the forks between the bars of the box as shown in the figure. Make sure the side towards the operator is the one with the labels on it.



Figure 3.3: Transportation by Forklift - rear side

5. Make sure the forks of the fork lift are longer than the box and projects out of the back of the box as shown in the figure.
6. Now lift the fork and move the box to the site.

## 3.5 Transportation with a Crane

A crane is recommended for lifting the cryostat out of the box.

**Approved Persons:** Approved crane operator

**Precondition:** The crane must be approved for the transportation weight (see **Appendix, Technical Data**).

### Attachment Points

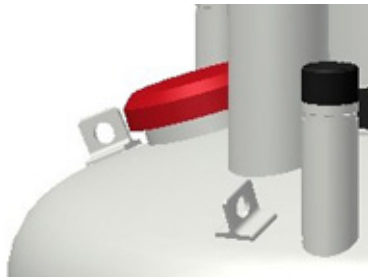

1. Exclusively use the marked eyelets as attachment points for the lifting equipment.
2. Use **all** eyelets for the lifting equipment.

Figure 3.4: Attachment Points for Lifting Equipment

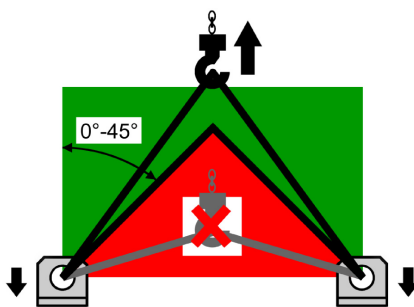

3. Follow the instructions on the label on top of the cryostat. This label gives important information about correct attachment and transportation.
4. Check for correct fastening of the lifting equipment before lifting the cryostat.
5. Make sure that any movement of the crane is as slowly as possible to avoid any damage due to acceleration.
6. Check for correct leveling of the cryostat while hanging on the crane.

Figure 3.5: Instruction Label for Lifting Equipment

## 3.6 Storing

---

If it is necessary to store the cryostat and accessories before installation obey the following instructions:

- Store the boxes in a closed, dry and dust-free room.
- Store the boxes upright.
- Do not tilt the boxes.
- Do not unpack the supplied boxes.
- Prevent mechanical vibrations to the boxes.
- Storage temperature: 5 - 40 °C.
- Storage humidity: less than 50% @ 23 °C.

## 3.7 Disposal

---

For disposal after the life cycle please contact Bruker Service for further information. For contact information see page 9 of this document.



# 4 Assembling

## 4.1 Safety

---

Approved Persons: Bruker Service only



# 5 Operation

## 5.1 Safety

---

### Approved Persons

Bruker Service, Approved Customer Personnel

### WARNING



**Magnetic Field** (see [page 18](#))

**Cryogenic Agents** (see [page 19](#))

**Electricity** (see [page 19](#))

**Gas under Pressure** (see [page 20](#))

## 5.2 Set into Operation

---



Figure 5.1: Start the Magnet Stand

If the magnet system is equipped with a magnet stand with pneumatic isolators:

Set the magnet stand into operation by switching the pneumatic controller to UP position.



Figure 5.2: Stop the Magnet Stand

For any work at the magnet system like maintenance or refill of cryogenic agents stop the magnet stand by switching the pneumatic controller to DOWN position.

# 6 Troubleshooting

Troubleshooting must be performed only with approved qualification.

In case of doubts or problems not specified in the following list contact Bruker Service immediately. For contact information see page 9 of this manual.

## 6.1 Safety

---

### Approved Persons

Bruker Service, Approved Customer Personnel

### WARNING



**Magnetic Fields** (see [page 18](#))

**Cryogenic Agents** (see [page 19](#))

**Electricity** (see [page 19](#))

**Gas under Pressure** (see [page 20](#))

**Spontaneous Ignition and Explosion** (see [page 21](#))

### Personal protective equipment

Protective goggles

Protective gloves

Protective clothes

Safety shoes

## 6.2 Problem

---

### 6.2.1 During Transportation

---

Indicator	Possible reason	Solution	By
Tilt Watch / Shock Watch activated.	Careless transportation.	<ol style="list-style-type: none"> <li>1. Accept delivery with reservation.</li> <li>2. Remark the extent of damage in the transportation documents.</li> <li>3. Start complaint process.</li> </ol>	Approved Customer Personnel
Visible damage.	Careless transportation.	<ol style="list-style-type: none"> <li>1. Accept delivery with reservation.</li> <li>2. Remark the extent of damage in the transportation documents.</li> <li>3. Start complaint process.</li> </ol>	Approved Customer Personnel

### 6.2.2 During Assembling

---

Indicator	Possible reason	Solution	By
Ceiling height too low for assembling on magnet stand.	Site does not meet the required conditions.	Choose another site that meets the required conditions.	Bruker Service
Ceiling height too low for inserting the Helium Level Sensor	Site does not meet the required conditions.	Insert the Helium Level Sensor before mounting the magnet stand.	Bruker Service
Helium bore tube and radiation shield are not concentric.	Alignment is not correct.	Check fixation of the alignment rods.	Bruker Service

Continued on next page

Continued from page before

Indicator	Possible reason	Solution	By
Helium bore tube and radiation shield are not concentric.	Alignment rod is loose or broken.	Replace alignment rod <sup>a</sup> .	Bruker Service
	Reduction flange is not concentric.	Check orientation.	Bruker Service
Vacuum Valve collides with the magnet stand.	Vacuum Valve collides with the magnet stand.	Turn the Vacuum Valve. Be careful if the RT vessel is evacuated.	Bruker Service
Vacuum in RT vessel does not reach $5 \times 10^{-5}$ mbar in 48 hours.	O-rings may be damaged.	Check and clean O-rings and slots; replace O-rings if necessary: <ul style="list-style-type: none"> <li>• of the Vacuum Valve</li> <li>• of the drop-off plate</li> <li>• of the reduction and sealing flanges</li> <li>• of the bottom plate <sup>a</sup></li> </ul>	Bruker Service
	Defective pumping unit or pumping line.	Check pumping unit and pumping line: A vacuum less than $10^{-6}$ mbar must be reached with a closed sealing plug. Replace if necessary.	Bruker Service
	Room temperature bore tube has scratches or dust on the sealing surfaces.	Check sealing surfaces on the room temperature bore tube: No scratches and no dust should be visible.	Bruker Service
	Moisture in the RT vessel.	Pump and flush the RT vessel several times with dry nitrogen gas.	Bruker Service
Super insulation touches RT vessel or bore tube or radiation shield.	Super insulation was not fixed correctly during assembly.	Fix super insulation on the outer radiation shield with polyester tape <sup>a</sup> . Carefully prevent any connection between different vessels or bore tubes in the cryostat.	Bruker Service

a. For this work the bottom plate has to be removed. Check the suspension tubes of the helium vessel are not broken. Install the safety device for fall protection (not supplied). Contact Bruker Service for further information.

## 6.2.3 During Cooling Down

Indicator	Possible reason	Solution	By
Cooling with liquid nitrogen continues too slowly.	Empty transportation dewar.	Refill or replace transportation dewar.	Bruker Service
	Transfer pressure too low.	Increase transfer pressure slightly (max. pressure 0.3 bar).	Bruker Service
	Transportation dewar is leaky; no transfer pressure can be applied.	Check transportation dewar and replace if necessary.	Bruker Service
Precooling with liquid nitrogen continues too quickly.	Transfer pressure too high.	Stop cooling. Adjust correct transfer pressure.	Bruker Service
Vacuum in RT vessel does not reach $5 \times 10^{-5}$ mbar in 48 hours.	O-rings may be leaky.	Check and clean O-rings and slots; replace O-rings if necessary: <ul style="list-style-type: none"> <li>• of the Vacuum Valve</li> <li>• of the drop-off plate</li> <li>• of the reduction and sealing flanges</li> <li>• of the bottom plate <sup>a</sup></li> </ul>	Bruker Service
	O-rings may be frozen due to contact with liquid nitrogen.	<ol style="list-style-type: none"> <li>1. Stop cooling.</li> <li>2. Warm up O-ring with warm air</li> <li>3. Wait until the vacuum recovers.</li> <li>4. Prevent liquid nitrogen from splashing on O-rings.</li> </ol>	Bruker Service
	Defective pumping unit or pumping line.	Check pumping unit and pumping line: A vacuum less than $10^{-6}$ mbar must be reached with a closed sealing plug. Replace if necessary.	Bruker Service

a. see note on page before

Continued on next page

Continued from page before

Indicator	Possible reason	Solution	By
RT vessel becomes cold and wet.	Vacuum is broken or less than $10^{-3}$ mbar.	<ul style="list-style-type: none"> <li>• Do not remove pumping unit until liquid helium fill-in is finished.</li> <li>• Continue as in problem <i>Vacuum in RT vessel does not reach <math>10^{-6}</math> mbar</i></li> </ul>	Bruker Service
	Cold leak after transportation.	<ol style="list-style-type: none"> <li>1. Stop cool down.</li> <li>2. Warm up cryostat.</li> </ol>	Bruker Service
Cold spot in the RT-bore.	Alignment not correct.	<ol style="list-style-type: none"> <li>1. Stop cool down.</li> <li>2. Warm up cryostat.</li> <li>3. Align the vessels.</li> </ol>	Bruker Service
The helium flow system becomes very cold and icy during flushing with helium gas.	Liquid nitrogen remains in the helium vessel, boiling off strongly during flushing.	<ol style="list-style-type: none"> <li>1. Stop flushing.</li> <li>2. Carefully remove all liquid nitrogen using the precooling tube.</li> <li>3. Check with the dipstick to be sure that the helium vessel is completely empty (no liquid nitrogen or frozen nitrogen).</li> </ol>	Bruker Service
After some intervals of flushing it is not possible to reach a vacuum in the range of 1 mbar.	The globes in the quench valves are not fitting correctly in the O-rings and thus the quench valves are leaky.	<ol style="list-style-type: none"> <li>1. Stop pumping.</li> <li>2. Remove frozen air and frozen moisture with warm helium gas.</li> <li>3. Slightly grease the O-rings and check the position of the globes.</li> <li>4. Check with the dipstick to be sure that the helium vessel is completely empty (no liquid nitrogen or frozen nitrogen).</li> </ol>	Bruker Service
	Liquid nitrogen remains in the helium vessel, boiling off strongly during flushing.	<ol style="list-style-type: none"> <li>1. Stop pumping.</li> <li>2. Carefully remove all liquid nitrogen using the precooling tube.</li> <li>3. Check with the dipstick to be sure that the helium vessel is completely empty (no liquid nitrogen or frozen nitrogen).</li> </ol>	Bruker Service

Continued on next page

Continued from page before

Indicator	Possible reason	Solution	By
Nitrogen ice in the helium vessel.	Times between pumping and flushing were too long; remaining nitrogen was boiling off during pumping and got frozen during flushing.	<ol style="list-style-type: none"> <li>1. Warm up the magnet coil with warm helium gas through the precooling tube until the whole coil is at 90 K or above.</li> <li>2. Repeat pumping and flushing and carefully check with the dipstick to be sure that the helium vessel is completely empty (no liquid nitrogen or frozen nitrogen).</li> </ol>	Bruker Service
Transfer of liquid helium does not start.	Empty transportation dewar .	Refill or replace transportation dewar.	Bruker Service
	The transfer pressure in the transportation dewar is too low.	Increase the transfer pressure.	Bruker Service
	The transportation dewar is leaky, no transfer pressure built up.	Check the transportation dewar for leakage. Re-tighten all connections.	Bruker Service
	The siphon or the helium transfer line are blocked with ice.	Check the siphon and helium transfer line for blockages, remove ice with warm helium gas.	Bruker Service
The cooling down of the magnet coil does not continue although helium is transferred.	The helium transfer line is defective.	Check the helium transfer line for icing. If there are cold spots visible, replace the helium transfer line.	Bruker Service
	The extension piece is not mounted on the helium transfer line.	Mount the extension piece on the helium transfer line. Check the helium transfer line to be inserted completely into the siphon.	Bruker Service

Continued on next page

Continued from page before

Indicator	Possible reason	Solution	By
The zero reading of the Helium Level Sensor can not be adjusted at the beginning of cooling down with liquid helium.	The Helium Level Sensor is not connected correctly with the connector in the helium flow system.	Check the connection in the helium fill-in turret between Helium Level Sensor and connector.	Bruker Service
	The Helium Level Sensor is defective.	Check the Helium Level Sensor with the 0% calibration plug.	Bruker Service
The helium level does not reach 100% after cooling down.	Empty transportation dewar, helium transfer stopped.	Refill or replace transportation dewar.	Bruker Service
	The Helium Level Sensor is disturbed by the transfer line's extension piece.	<ol style="list-style-type: none"> <li>1. Stop the liquid helium transfer.</li> <li>2. Remove the transfer line.</li> <li>3. Measure the helium level after some minutes without the transfer line.</li> </ol>	Bruker Service
After cooling down the helium boil off is higher than specified (up to 5 times).	Usual behavior. A few days are necessary for the radiation shields and the insulation to reach scheduled temperatures.	<p>Wait a few days and check helium boil off.</p> <p>The presence of the current lead in the current lead turret during energizing and shimming helps to cool down the radiation shield due to higher helium flow.</p>	Bruker Service

## 6.2.4 During Energizing and Shimming

Indicator	Possible reason	Solution	By
The current lead can not be inserted completely into the connector.	The connector is covered with ice (frozen moisture or nitrogen ice).	Carefully remove the ice with warm helium gas. Use the dipstick or the precooling tube as tubing for the warm helium gas to remove small ice spots.	Bruker Service
	The shorting plug was not removed.	Remove the shorting plug with the shorting plug tool.	Bruker Service
	The orientation of the current lead is not correct.	Turn the current lead carefully until it can be inserted correctly into the connector.	Bruker Service
Main coil heater test fails.	Defective Power Supply.	Replace the Power Supply	Bruker Service
	Connector or cables defective.	Clean connectors or replace cables if necessary.	Bruker Service
Setting of sense voltage fails.	The main coil heater switch is "OFF". The main coil switch is not opened.	Switch the main coil heater to "ON" and check the main coil heater current to be adjusted correctly.	Bruker Service
	The main coil heater current is not correct. The main coil switch is not opened.	Adjust main coil heater current correctly.	Bruker Service
	The auxiliary shorting plug is inserted in the current lead turret by mistake and makes a short circuit across the main coil.	Remove the auxiliary shorting plug and insert it in the helium fill-in turret.	Bruker Service
Current lead can not be removed.	The connector is covered with ice (frozen moisture or nitrogen ice).	Carefully remove the ice with warm helium gas over the helium flow system. Use the dipstick or the precooling tube as tubing for the warm helium gas to remove small ice spots from the connector.	Bruker Service

Continued on next page

Continued from page before

Indicator	Possible reason	Solution	By
Shorting plug can not be removed.	The connector is covered with ice (frozen moisture or nitrogen ice).	Carefully remove the ice with warm helium gas. Use the dipstick or the precooling tube as tubing for the warm helium gas to remove small ice spots from the connector.	Bruker Service
The magnet system quenches.	Loss of superconductivity.	See chapter "After a Quench" on page 53.	Bruker Service
	The helium level was too low for energizing, cycling, shimming, de-energizing or sweeping.	See chapter "After a Quench" on page 53.	Bruker Service
	The Power Supply is defective. The main current is oscillating.	Replace the Power Supply.	Bruker Service
The main coil switch can not be closed on field.	The helium level is too low for energizing. The main coil switch is not covered with liquid helium.	Never try to energize the magnet with less than the "minimum level during energizing" in the helium vessel.	Bruker Service
	The Power Supply is defective. The main current is oscillating.	Replace the Power Supply.	Bruker Service
Shim current can not be set correctly.	The control cable is not connected correctly to the current lead or to the Power Supply.	Connect the control cable correctly to current lead and power supply.	Bruker Service
	Switch „Main Coil/OFF/Shim Coil“ in wrong position.	Change the switch position.	Bruker Service
Shims do not affect the NMR signal.	Shim heater current is not correct. The shim switches are not opened.	Set the shim heater current to the specified value (see <b>Appendix Technical Data</b> ).	Bruker Service

Continued on next page

Continued from page before

Indicator	Possible reason	Solution	By
Magnet system does not reach specification.	Magnetic material inside RT bore tube.	Carefully clean the RT bore tube.	Bruker Service
	Large ferromagnetic parts near the magnet system.	<ol style="list-style-type: none"> <li>1. Keep the maximum possible distance between the magnet system and ferromagnetic parts.</li> <li>2. Repeat shimming.</li> </ol>	Bruker Service

## 6.2.5 During Operation of the Magnet Stand

In case of doubt contact Bruker Service and refer to the manual of the Magnet Stand.

Indicator	Possible reason	Solution	By
The NMR spectrum shows massive disturbances.	Pneumatic controller is in DOWN position.	Switch pneumatic controller to UP position.	Approved Customer Personnel
	Magnet system has direct mechanical contact with the floor via accessories or cables.	Identify and eliminate contact point. Arrange cables in loose S- or U-shapes.	Approved Customer Personnel
		If the problem is still not solved, contact Bruker Service.	Approved Customer Personnel
	Magnet system has physical contact to the magnet stand.	Check leveling; adjust if necessary.	Bruker Service
	Piston of the isolator is not centric or touches its casing.	Align magnet stand.	Bruker Service
	T-safety bracket touches the pillar.	Align magnet stand.	Bruker Service
	Floor vibrations in vertical direction.	Replace elastomeric isolators with air damped isolators.	Bruker Service
	Floor vibrations in horizontal and vertical direction.	Replace air damped isolators with air piston isolators.	Bruker Service

Continued on next page

Continued from page before

Indicator	Possible reason	Solution	By
The pneumatic isolator of the magnet stand does not reach the operating position.	Pneumatic controller in DOWN position.	Switch pneumatic controller to UP position.	Approved Customer Personnel
	The pressure of the pneumatic supply is too low.	Check the pressure of the pneumatic supply. It must be in the range of 5 to 8 bar (70 to 112 psi).	Approved Customer Personnel
		If the problem is still not solved, contact Bruker Service.	Approved Customer Personnel
	The magnet system is not leveled correctly.	Stop the pneumatic isolators. Check the leveling of the cryostat.	Bruker Service
	Defective leveling valve.	Replace leveling valve or isolator.	Bruker Service
	Defective membrane of an isolator.	Replace leveling valve or isolator.	Bruker Service
Magnet system achieves working position jerkily.	Piston is not centric or touching its casing.	Align magnet stand.	Bruker Service
Audible loss of air.	Defective membrane or defective leveling valve of an isolator.	Replace leveling valve or isolator.	Bruker Service
	Hose connector is defective or loose.	Insert hoses correctly and tighten screws.	Bruker Service
Velocity of lifting or lowering too high.	Wrong adjustment of the flow control valve.	Close restrictor of the flow control valve completely; then open it a half turn.	Bruker Service

## 6.2.6 During Standard Operation

Indicator	Possible reason	Solution	By
The helium boil off decreases to zero.	The atmospheric pressure is increasing.	Usual behavior. Watch helium boil off daily.	Approved Customer Personnel
	The helium flow system is covered with ice.	Contact Bruker Service immediately! Do not try to remove ice of the helium flow system!	Approved Customer Personnel
		<b>⚠ WARNING:</b> <b>Cryogenic Agents</b> <b>Quench</b>	
	The helium flow system or the suspension tubes are blocked with ice.	Blow in warm helium gas carefully through an applicable tube. Do not insert it more than 600 mm from the top of the helium turrets.	Bruker Service
The helium boil off is too high.	The Helium Level Sensor is permanently on (service mode) or used often.	Switch off Helium Level Sensor. Reduce frequency of helium level measurement (during measuring of the helium level an amount of helium boils off due to the heat input of the Helium Level Sensor; for reporting the helium boil off one weekly measurement is sufficient).	Approved Customer Personnel
	The atmospheric pressure is decreasing.	Usual behavior. Watch helium boil off daily.	Approved Customer Personnel
		If the problem is still not solved, contact Bruker Service.	Approved Customer Personnel

Continued on next page

Continued from page before

Indicator	Possible reason	Solution	By
Continue of: The helium boil off is too high.	Vacuum reduced.	Rebuild vacuum, see chapter <b>"Rebuilding Vacuum" on page 52</b>	Bruker Service
	The radiation baffles are not inserted in the current lead turret.	Insert the radiation baffles into the current lead turret.	Bruker Service
Quench.	Loss of superconductivity.	See chapter <b>"After a Quench" on page 53</b> Contact Bruker Service immediately!	Approved Customer Personnel
Cold spots within the RT bore.	Alignment of the vessels not correct.	Contact Bruker Service.	Approved Customer Personnel
RT vessel is wet and cold.	Vacuum reduced.	Contact Bruker Service immediately!	Approved Customer Personnel
Not correct helium level warning out of MICS.	Helium Level Sensor defective.	Contact Bruker Service immediately!	Approved Customer Personnel
Helium level at constant level, no change during days.	Helium Level Sensor defective.	Contact Bruker Service immediately!	Approved Customer Personnel
		<b>⚠ WARNING:</b> <b>Low Temperature</b>	
Not correct helium level warning out of MICS.	Helium Level Sensor defective.	Replace Helium Level Sensor (see chapter <b>"Replacement of the Helium Level Sensor" on page 87</b> )	Bruker Service
Helium level at constant level, no change during days.	Helium Level Sensor defective.	Replace Helium Level Sensor (see chapter <b>"Replacement of the Helium Level Sensor" on page 87</b> )	Bruker Service

## 6.2.7 During De-energizing and Warming up

Indicator	Possible reason	Solution	By
The magnet system quenches during de-energizing.	The helium level was too low for de-energizing.	Refill helium at least to the minimum allowed level (see <b>Appendix, Technical Data</b> ).	Bruker Service
	The Power Supply is defective.	Replace Power Supply.	Bruker Service
	The main current is oscillating.	Replace Power Supply.	Bruker Service
The shim current can not be set correctly.	The control cable is not connected correctly to the current lead and/or the Power Supply.	Connect the control cable to the current lead and to the Power Supply correctly.	Bruker Service
	The switch "Main Coil/OFF/Shim Coil" is not on the "Shim Coil" position.	Switch "Main Coil/OFF/Shim Coil" on the "Shim Coil" position.	Bruker Service
High helium flow after breaking vacuum.	Remaining cryogenic agents in the vessels.	Remove liquid cryogenic agents.	Bruker Service
Vacuum still remains after 12 hours.	Vacuum Valve is closed.	Open the Vacuum Valve. Block it if necessary.	Bruker Service
RT vessel is wet and cold.	Cryostat is still cold.	Wait until RT vessel is dry and warm. Check PT100 temperature sensors.	Bruker Service
RT bore wet and cold before disassembling.	Cryostat is still cold.	Wait one more day. Do not open a cryostat before the room temperature bore tube is warm and dry!	Bruker Service

## 6.3 Troubleshooting Work

### 6.3.1 After a Quench



Figure 6.1: Quench Picture

A quench is the very fast de-energizing of the magnet by loss of its superconductivity. The stored magnetic energy is converted into heat, which promotes rapid evaporation of large quantities of helium. After an appearance of a quench contact Bruker Service immediately.



#### **WARNING**

**Cryogenic Agents** (see [page 19](#))

**Quench** (see [page 20](#))

#### **Quench while in persistent mode:**

1. Wait until the quench valves are closed and no helium evaporates out of the quench valves.
2. Wait until there is no helium vapor visible in the room or the ceiling to make sure there is sufficient oxygen in the room.
3. If equipped with switch the Atmospheric Pressure Device OFF.
4. Check the globes in the quench valves for their correct position.
5. Only at magnet systems with 3 helium turrets: check the bursting disc at the helium flow system. If destroyed close the socket with the supplied plug to prevent air from entering the helium flow system or vessel.
6. Remove probe and shim system to prevent icing of the shim system.
7. Check the nitrogen turrets for icing.
8. Start the refill with liquid helium as soon as possible after the quench (within one hour after the quench; refer to the supplied Refilling Procedure).
9. Contact Bruker Service immediately.

- 
- i** If the quench occurs unattended or helium transfer was not possible within one hour after the quench, it is recommended to warm up the system to 90 K.
-

# 7 Maintenance

Maintenance must be performed only with approved qualification.

In case of doubt contact Bruker Service. For contact information see page 9 of this document.

## 7.1 Safety

---

### Approved Persons

Bruker Service, Approved Customer Personnel

### WARNING



**Magnetic Field** (see [page 18](#))

**Cryogenic Agents** (see [page 19](#))

**Electricity** (see [page 19](#))

**Gas under Pressure** (see [page 20](#))

**Low Temperatures** (see [page 21](#))

**Spontaneous Ignition and Explosion** (see [page 21](#))

### Personal protective equipment

Protective goggles

Protective gloves

Safety shoes

## 7.2 Cleaning

### Procedure

- Clean the RT vessel of the magnet system and the magnet stand with a dry or slightly damp cloth.
- Only use water and neutral detergents.
- Do not use volatile cleaning solvents.

## 7.3 Maintenance Timetable

Interval	Device	Work	By
daily	Cryostat	Check the helium flow.	Approved Customer Personnel
daily	Cryostat	Check the nitrogen flow.	Approved Customer Personnel
weekly	Cryostat	<ul style="list-style-type: none"> <li>• Check the helium level.</li> <li>• Refill liquid helium if necessary according to the supplied Refilling Procedure respecting the warnings and instructions given there.</li> <li>• Record the filling session. Deviation from estimated consumption may be used for identification of troubles. In this case contact Bruker Service.</li> </ul>	Approved Customer Personnel
weekly	Cryostat	<ul style="list-style-type: none"> <li>• Check the nitrogen level.</li> <li>• Refill liquid nitrogen if necessary according to the supplied Refilling Procedure respecting the warnings and instructions given there.</li> <li>• Weekly refill is recommended.</li> <li>• Record the filling session. Deviation from estimated consumption may be used for identification of troubles. In this case contact Bruker Service.</li> </ul>	Approved Customer Personnel

Table 7.1: Maintenance Timetable

# 8 Disassembling

## 8.1 Safety

---

Approved Persons: Bruker Service only





# A Appendix

**Warning Signs**

**Figures**

**Tables**

**Glossary / Abbreviations**

**Technical Data**

**Index**



## A.1 Warning Signs

---

### Danger

Key Word and Symbol .....	15
---------------------------	----

### Warning

Cryogenic Agents .....	19
Electricity .....	19
Gas under Pressure .....	20
Heavy Weights .....	22
Intended Use .....	16
Key Word and Symbol .....	15
Low Temperatures .....	21
Magnetic Field .....	18
Persons .....	16
Quench .....	20
Safety Devices .....	17
Signs and Labels .....	18
Slippage .....	21
Spare Parts .....	17
Spontaneous Ignition and Explosion .....	21

### Caution

Incorrect Transportation .....	23
Key Word and Symbol .....	15

### Notice

Key Word and Symbol .....	15
---------------------------	----



## A.2 Figures

---

Figure 1.1:	General View of a Magnet System with 2 Helium Turrets .....	12
Figure 2.1:	Safety Devices of the Cryostat with 2 Helium Turrets.....	26
Figure 3.1:	Packaging (without surrounding panels).....	29
Figure 3.2:	Transportation by Forklift - front side .....	31
Figure 3.3:	Transportation by Forklift - rear side .....	31
Figure 3.4:	Attachment Points for Lifting Equipment.....	32
Figure 3.5:	Instruction Label for Lifting Equipment.....	32
Figure 5.1:	Start the Magnet Stand .....	38
Figure 5.2:	Stop the Magnet Stand .....	38
Figure 6.1:	Quench Picture .....	53
Figure A.1:	Dimension Cryostat - Front View .....	70
Figure A.2:	Dimension Cryostat - Top View .....	72
Figure A.3:	Nitrogen Level Graph .....	74
Figure A.4:	Helium Level Graph .....	75
Figure A.5:	Nitrogen Level Sensor .....	76
Figure A.6:	Helium Level Sensor .....	77
Figure A.7:	Characteristic Curve PT 100.....	78
Figure A.8:	Characteristic Curve IBT .....	79
Figure A.9:	Fringe Field Plot.....	81
Figure A.10:	Current Lead 55 pins .....	83
Figure A.11:	Wiring Diagram Magnet .....	84
Figure A.12:	Wiring Diagram Magnet - Control .....	85
Figure A.13:	Wiring Diagram Magnet - Diagnostic and Temperature Sensors .....	86
Figure A.14:	Shorting Plug 55 pins .....	87



### A.3 Tables

---

Table 7.1:	Maintenance Timetable .....	56
Table A.1:	Environmental Conditions .....	69
Table A.2:	Dimension Cryostat - Front View .....	71
Table A.3:	Dimensions Cryostat - Top View .....	72
Table A.4:	Cryogenic Agents.....	73
Table A.5:	Nitrogen Level Sensor .....	76
Table A.6:	Helium Level Sensor.....	77
Table A.7:	Characteristic Values PT 100.....	78
Table A.8:	Characteristic Values IBT.....	79
Table A.9:	Specification of the Magnet.....	80
Table A.10:	Fringe Field Values .....	81
Table A.11:	Resistance at Room Temperature .....	89
Table A.12:	Heater Currents .....	90
Table A.13:	Energizing Assignment and Currents .....	90
Table A.14:	Cycling Assignment (recommended only for 500 Mhz and more) .....	91
Table A.15:	Energizing Currents .....	92
Table A.16:	Deenergizing Assignment and Currents .....	93



## A.4 Glossary / Abbreviations

---

Glossary	Description
Box	Any kind of package used to protect sensitive parts during transportation.
Cryostat	The collective of all parts providing a temperature of 4 K inside for the superconducting magnet. The cryostat also provides the safety devices and the access ports for the cryogenic agents and electricity. The superconducting magnet inside the cryostat is not energized.
Dewar	Any kind of package used for transporting cryogenic agents like liquid helium or nitrogen.
Pressure Cylinder	Any kind of package used for transporting gaseous agents with a pressure up to 200 bar.
Magnet System	The collective of all parts necessary for the intended use. The superconducting magnet inside the cryostat is energized.

Abbreviations	Description
ACD	Automatic Cooling Device
MICS	Magnet Information and Control System
NMR	Nuclear Magnetic Resonance
RS	Radiation Shield
RT	Room Temperature; used as prefix of parts which are at room temperature



## A.5 Technical Data MS 600'54 Ascend

---

### A.5.1 Technical Data Cryostat

#### Environmental conditions

	Value	Unit
Minimum surrounding temperature	7	°C
Maximum surrounding temperature	38	°C
Maximum relative humidity up to 31°C	80	%
Maximum relative humidity between 31°C and 40°C linear decreasing	80-50	%

Table A.1: Environmental Conditions

#### Identification Plate

The identification plate is on the right back side of the cryostat fixed at the bottom plate.

##### Contents of the identification plate:

- Address of the Manufacturer
- Magnet System Identifier
- Type
- Identification Number
- Magnet Identifier
- Serial Number
- Year of Construction
- Cryostat Identifier
- Specification Helium Vessel
- Specification Nitrogen Vessel
- Specification Vacuum Chamber
- Weight total (empty / full)

## Dimensions Cryostat

Front view

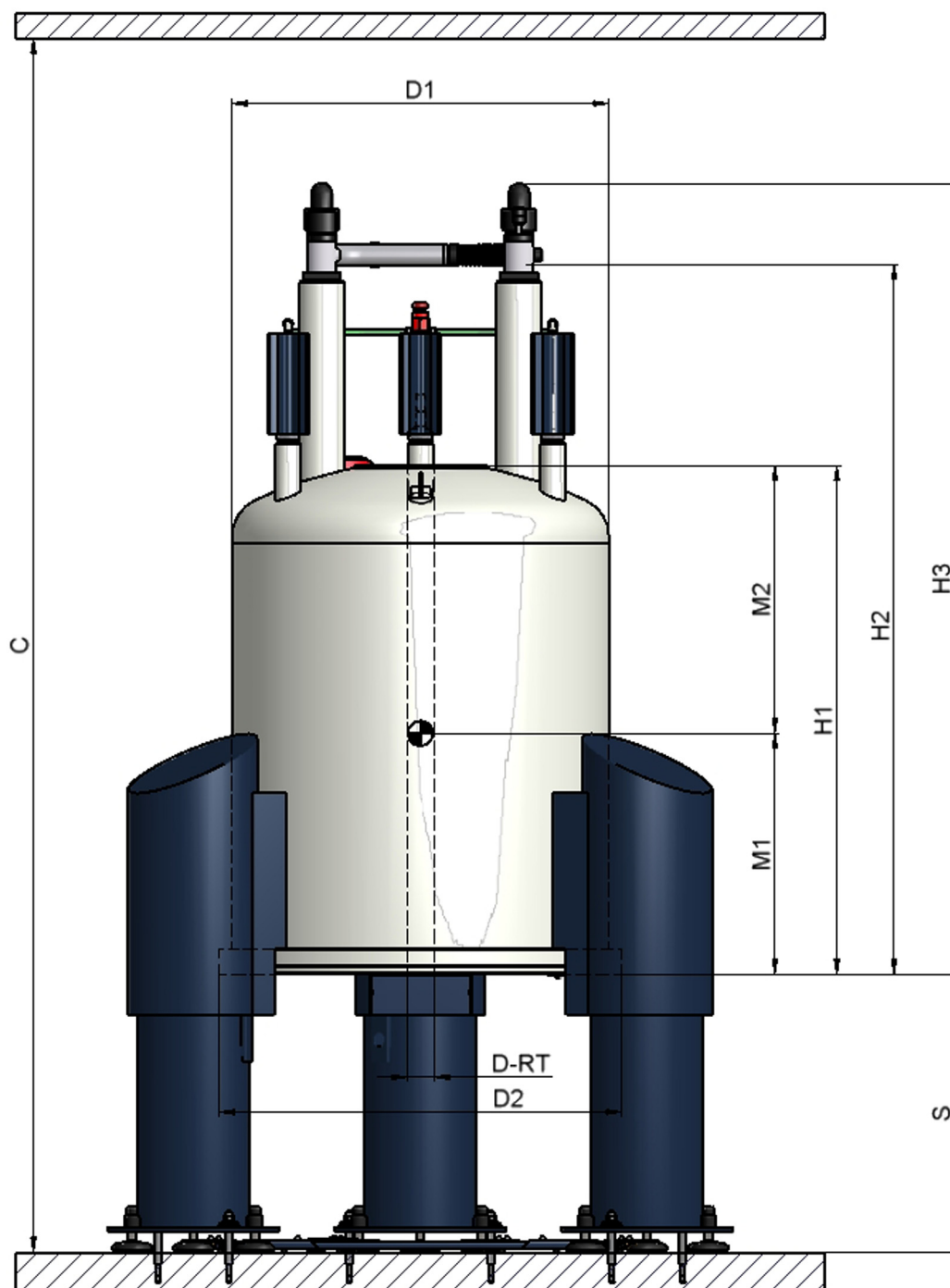

⊙ = magnetic center  
1 mT = 10 Gauss

Z1044563

Figure A.1: Dimension Cryostat - Front View

Dimensions Cryostat	Value	Unit
C Operational Ceiling Height	2845	mm
D-RT Diameter RT Bore Tube	54	mm
D1 Diameter RT vessel	745	mm
D2 Diameter Bottom Plate	795	mm
H1 Height Cryostat (bottom plate to top flange)	1205	mm
H2 Height Cryostat (minimum height for transportation)	1604	mm
H3 Height Cryostat (bottom plate to flow system)	1763	mm
S Height Magnet Stand (floor to bottom plate)	700	mm
M1 Distance magnetic Center to bottom flange (calculated)	415.6	mm
M2 Distance magnetic center to top flange (calculated)	789.4	mm

Table A.2: Dimension Cryostat - Front View

Top view

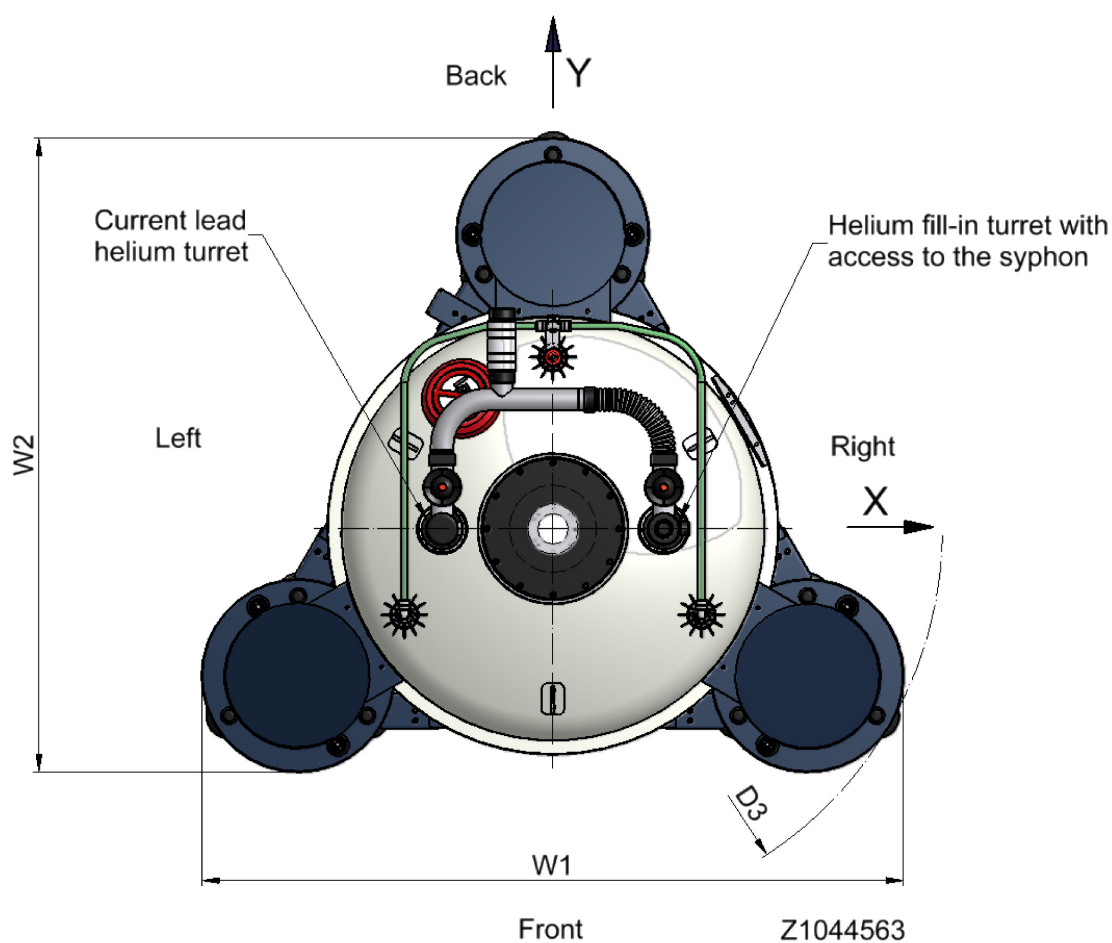

Figure A.2: Dimension Cryostat - Top View

Dimensions Cryostat	Value	Unit
W1	1236	mm
W2	1116	mm
D3 <sup>1</sup>	1375	mm

Table A.3: Dimensions Cryostat - Top View

1. Keep at least an additional free space of 1.5 m around the magnet system for service.

## Fill Volume, Evaporation Rate and Hold Time

Cryogenic Agents	Value	Unit
Nitrogen vessel total volume	134	l
Nitrogen refill volume	104	l
Nitrogen evaporation rate	240	ml/h
Nitrogen hold time <sup>1</sup>	18	days
Helium vessel total volume	90	l
Helium refill volume	58	l
Helium evaporation rate	16	ml/h
Helium hold time <sup>1</sup>	150	days
Helium refill volume after Quench (cool down and refill)	160	l

Table A.4: Cryogenic Agents

1. Maximum time intervall between two fillings

### Nitrogen Level Graph

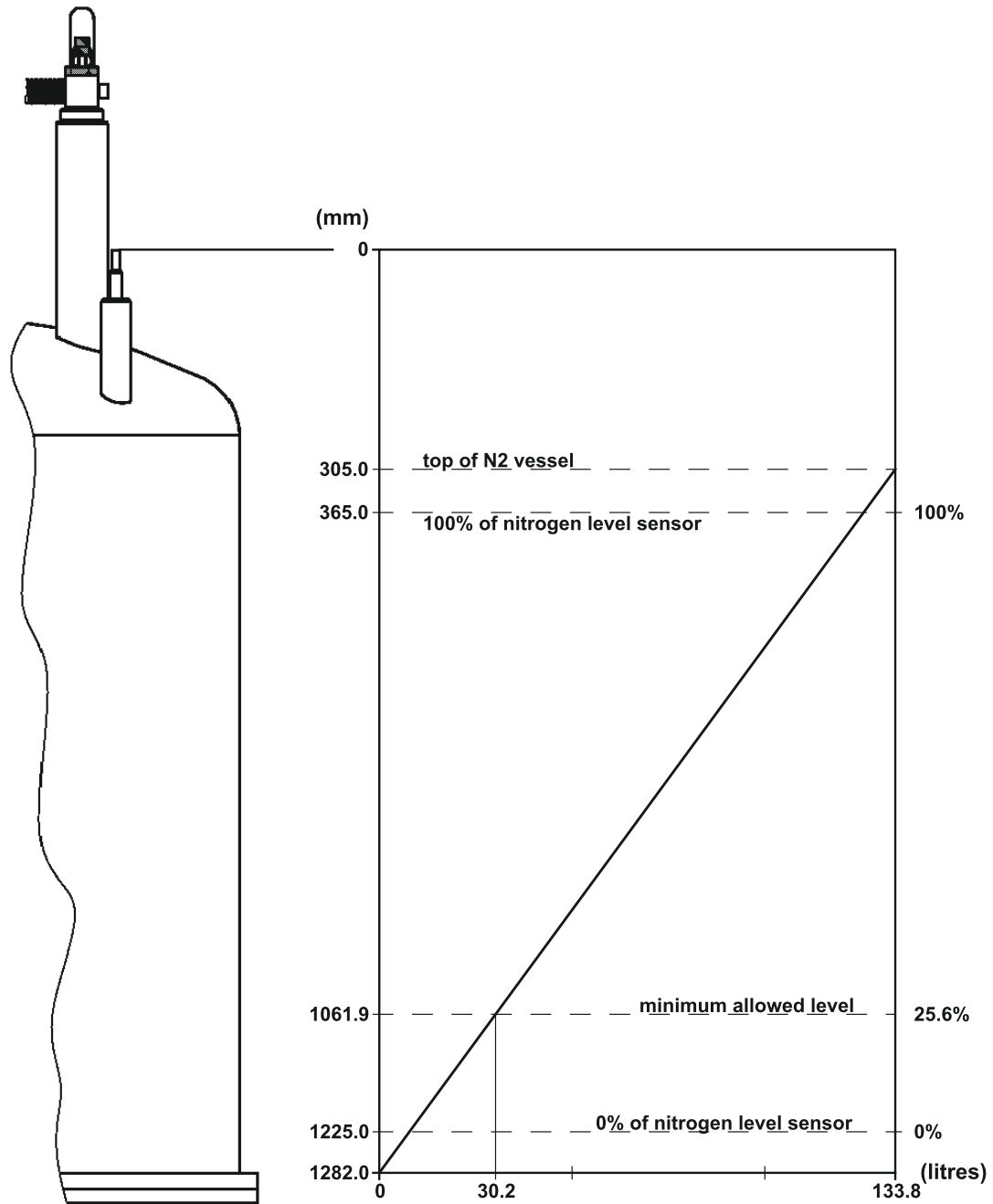

Figure A.3: Nitrogen Level Graph

### Helium Level Graph

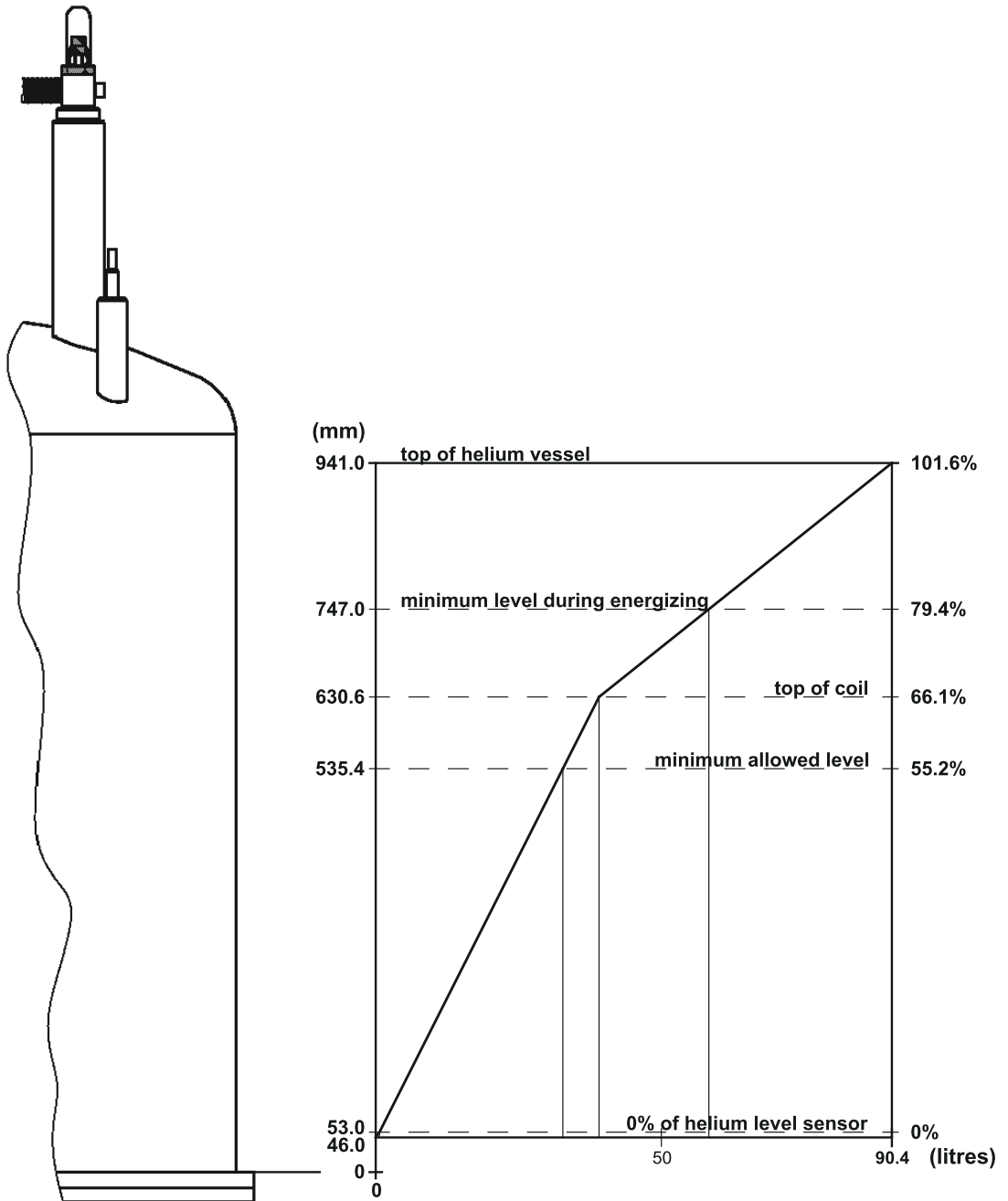

Figure A.4: Helium Level Graph

## Nitrogen Level Sensor

The Nitrogen Level Sensor is inserted in the recommended nitrogen turret. 6 lights display the nitrogen level.

Nitrogen Level Sensor	Material No.	Value	Unit
Level Sensor Type	Z122404	12/1126/860	
Diameter		12	mm
Overall length		1126	mm
Active length		860	mm

Table A.5: Nitrogen Level Sensor

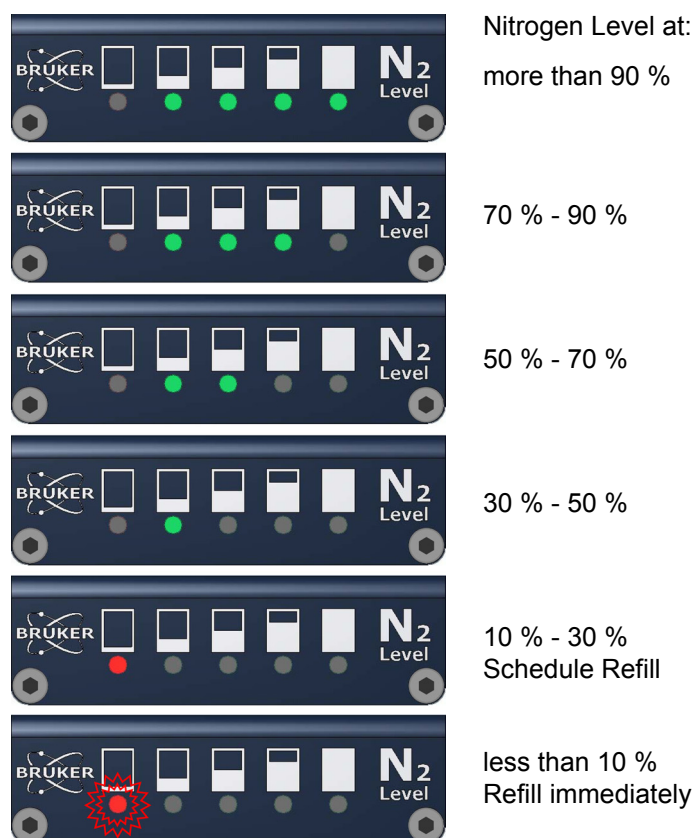

Figure A.5: Nitrogen Level Sensor

## Helium Level Sensor

The Helium Level Sensor is inserted in the helium fill-in turret.

Helium Level Sensor	Material No.	Value	Unit
Level Sensor Type	Z58103	1500/874	
Overall length		1500	mm
Active length		874	mm
Calibration 0 %, Calibration resistor	Z53168 violet	177	$\Omega$
Calibration 100 %, Calibration resistor	Z28628 black	15	$\Omega$

Table A.6: Helium Level Sensor

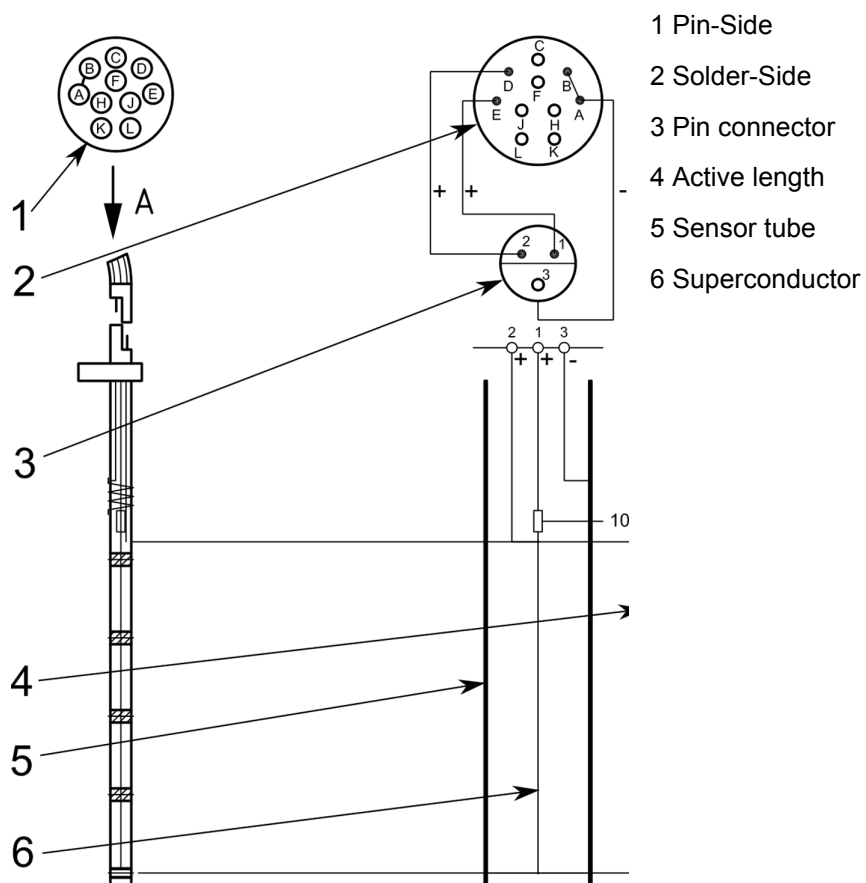

Figure A.6: Helium Level Sensor

## Temperature Sensors

The temperature sensors (PT 100 and IBT) will be used to monitor the temperature of the magnets during cooling and warming up of the magnet system.

### PT 100

- i** Measure the resistance with a maximum current of 1 mA.

	Temperature	Unit	Resistance	Unit
Room Temperature	293	K	107.8	$\Omega$
	273	K	100.0	$\Omega$
	250	K	91.0	$\Omega$
	200	K	71.1	$\Omega$
	150	K	50.9	$\Omega$
	100	K	30.0	$\Omega$
Liquid Nitrogen	77	K	20.1	$\Omega$

Table A.7: Characteristic Values PT 100

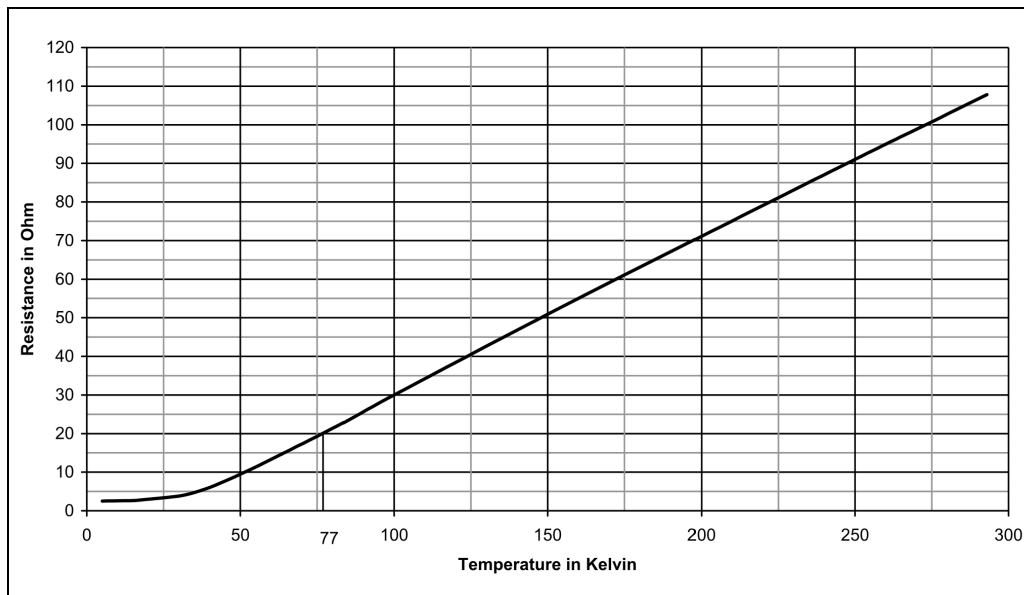

Figure A.7: Characteristic Curve PT 100

### IBT Carbon Resistor

**i** Measure the Resistance with a maximum current of 0.1 mA.

	Temperature	Unit	Resistance	Unit
Room Temperature	300	K	220	$\Omega$
Liquid Nitrogen	77	K	265	$\Omega$
	40	K	300	$\Omega$
	20	K	350	$\Omega$
	10	K	420	$\Omega$
	8	K	450	$\Omega$
	6	K	500	$\Omega$
	5	K	540	$\Omega$
Liquid Helium	4.2	K	575	$\Omega$

Table A.8: Characteristic Values IBT

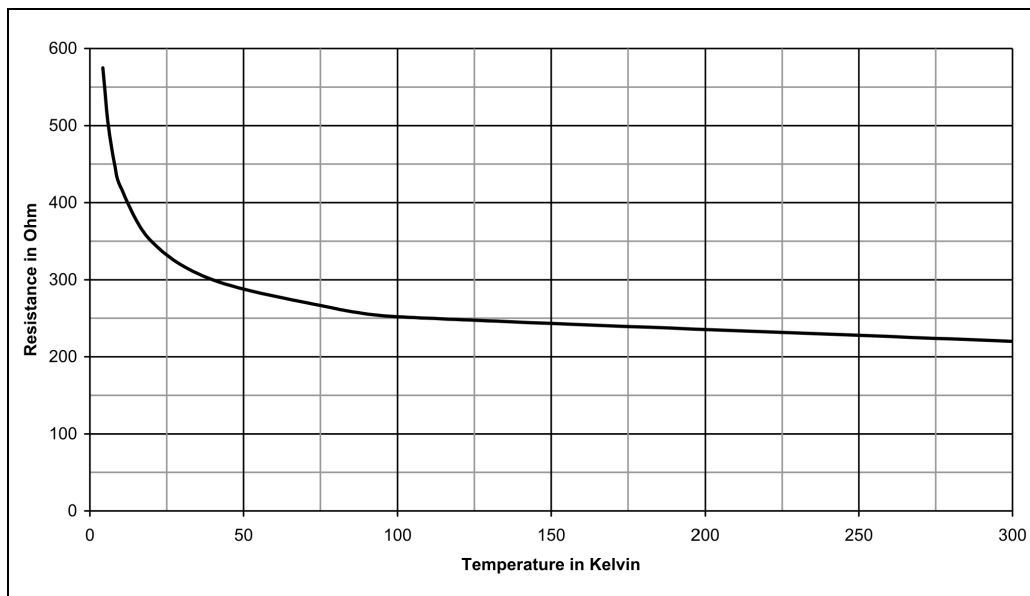

Figure A.8: Characteristic Curve IBT

## A.5.2 Technical Data Magnet

Technical Data Magnet	Value	Unit
Proton frequency	600	MHz
Central field	14.09	T
Coil inductance	46	H
Magnetic energy	774	kJ
Magnetic center from bottom flange (design value)	415.6	mm
Maximum drift rate	0.01	ppm/h
	6	Hz/h

Table A.9: Specification of the Magnet

### Operating modes of the Magnet System:

#### Driven Mode

In the driven mode the current lead is mounted and the electricity is flowing through the power supply. The coils of the magnet can be energized and de-energized.

#### Persistent Mode

In the persistent mode the electricity is flowing exclusively within the magnet. The circuit has no connection to the outside. The magnetic field cannot be switched off.

Fringe Field Plot

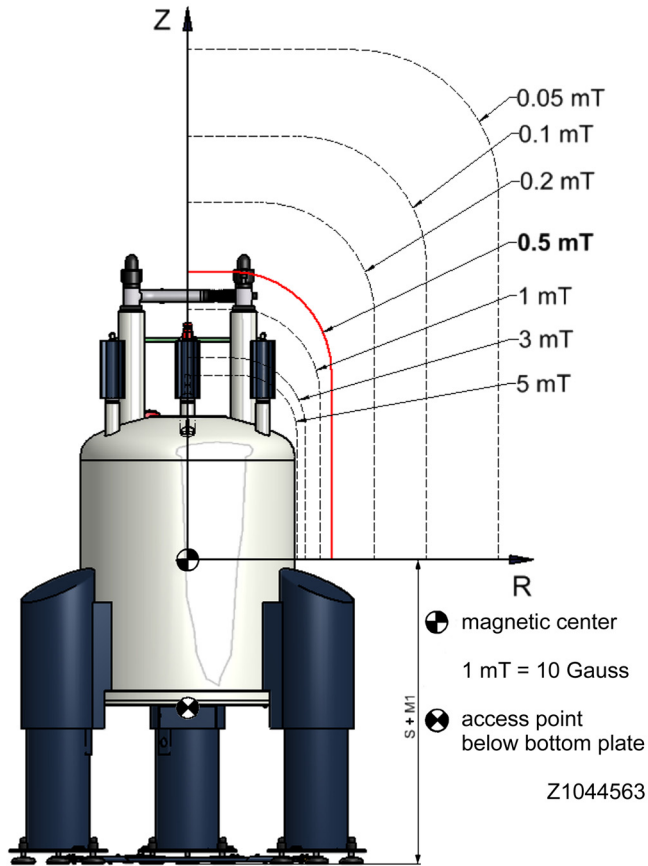

Figure A.9: Fringe Field Plot

Fringe Field	Unit	R max	Unit	Z max	Unit
200	mT	0.29	m	0.49	m
5.0	mT	0.51	m	0.88	m
3.0	mT	0.55	m	0.97	m
1.0	mT	0.63	m	1.21	m
0.5	mT	0.70	m	1.40	m
0.2	mT	0.93	m	1.74	m
0.1	mT	1.18	m	2.07	m
0.05	mT	1.55	m	2.50	m
<b>max magnetic field B0 at access point</b>				<b>306</b>	<b>mT</b>
<b>max field gradient dB/dz at access point</b>				<b>4.6</b>	<b>T/m</b>

Table A.10: Fringe Field Values

This page is intentionally left blank.

Current Lead

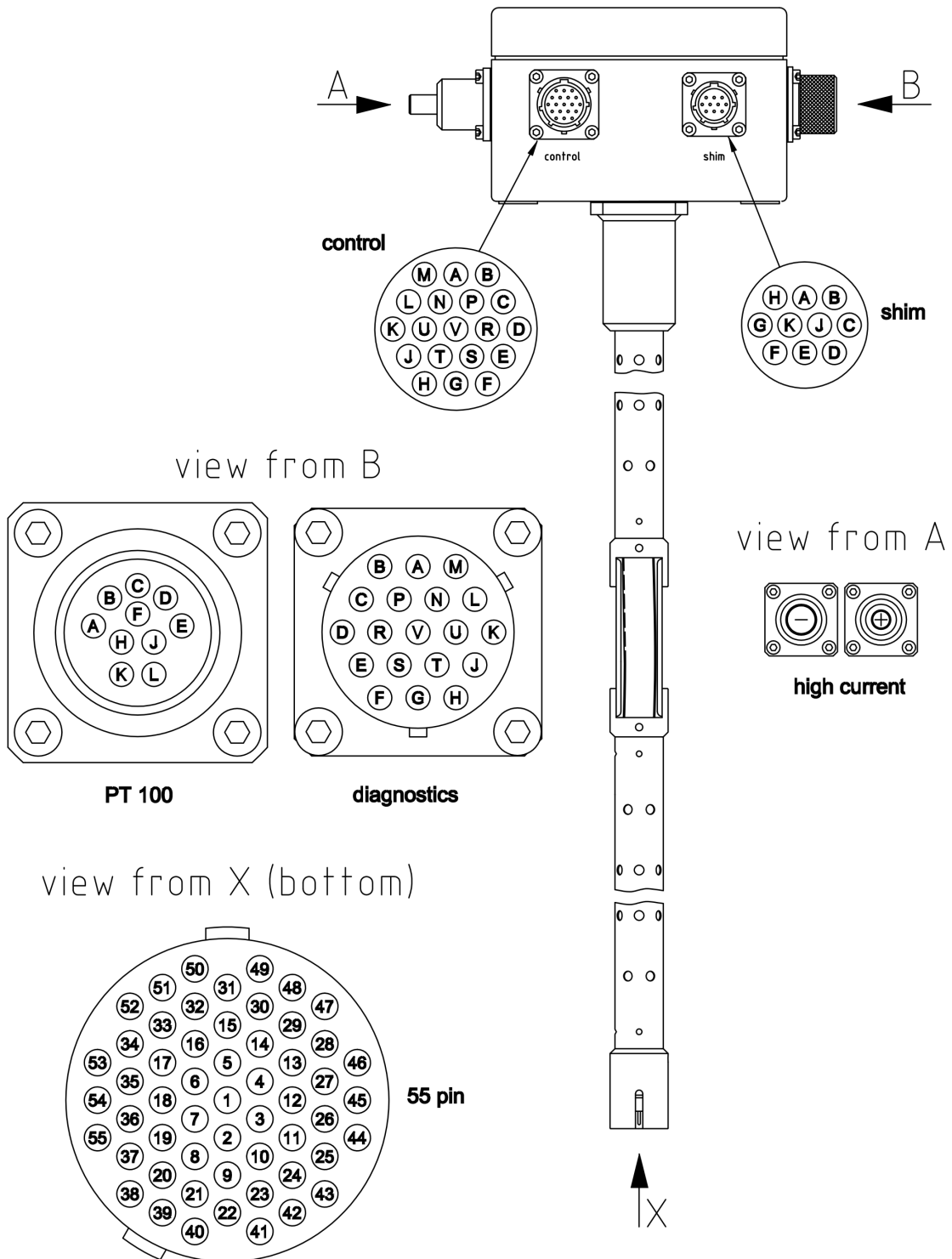

Z1029367

Figure A.10: Current Lead 55 pins

Wiring Diagram Magnet

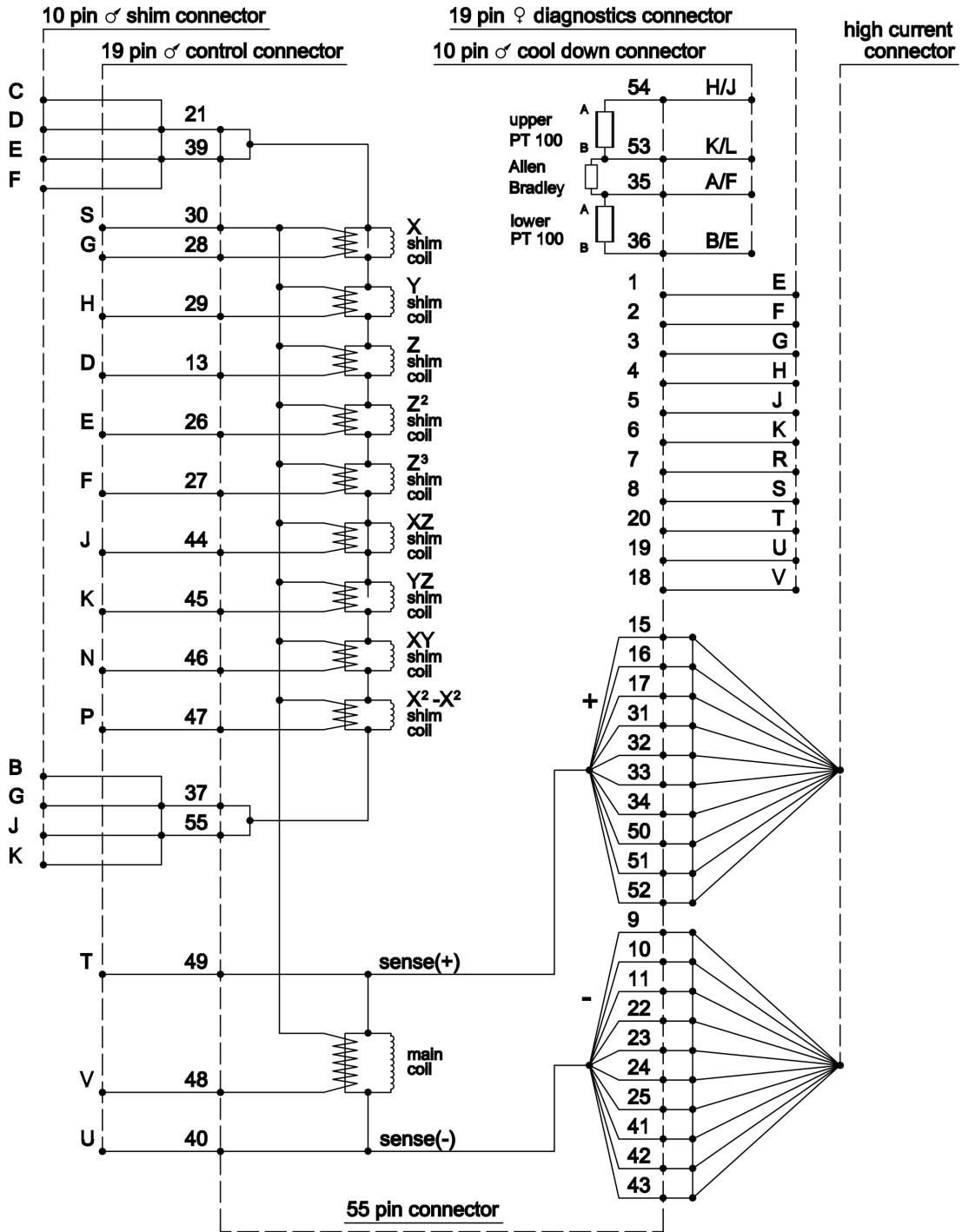

Z1030082

Figure A.11: Wiring Diagram Magnet

### Wiring Diagram Magnet Control

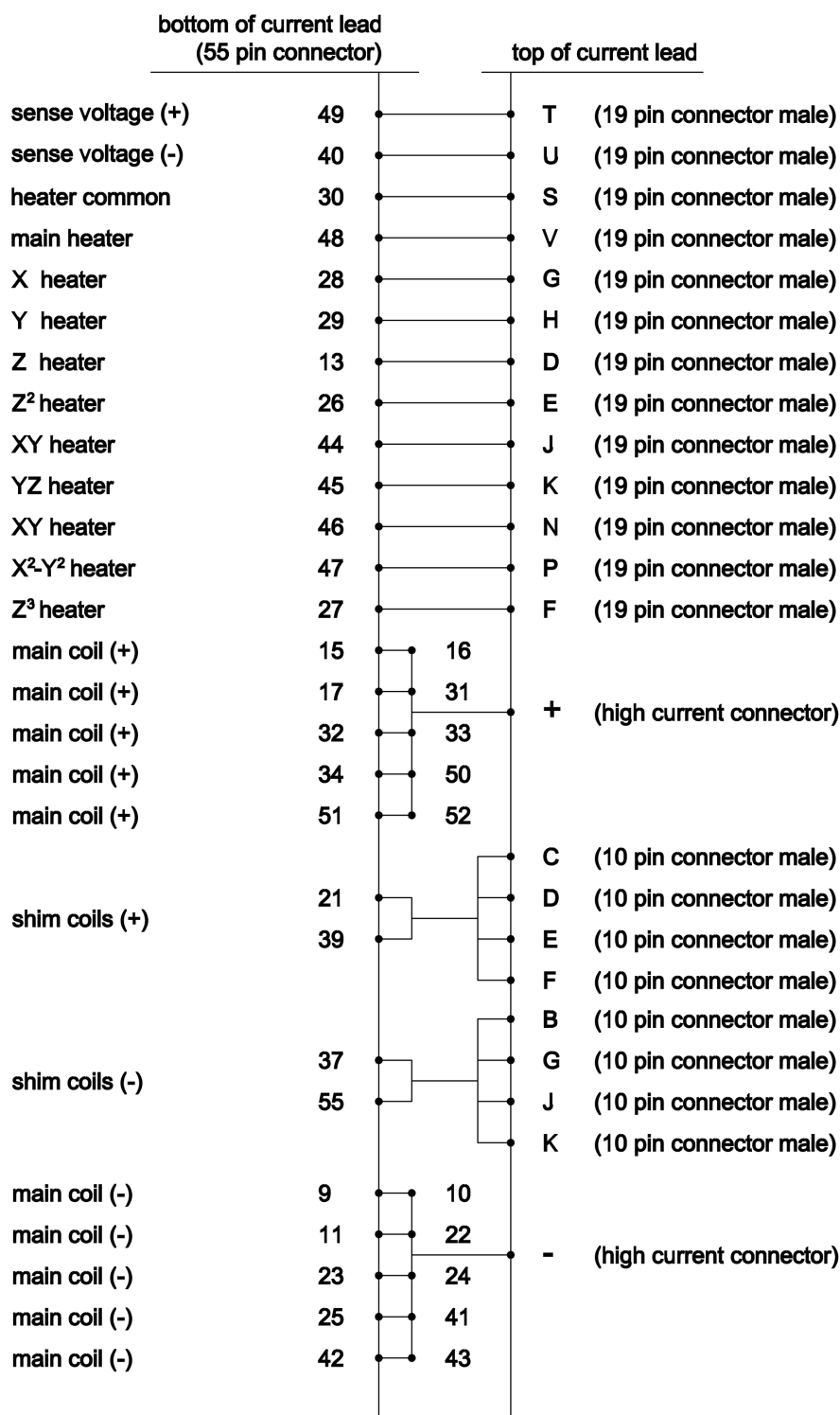

Z1029391

Figure A.12: Wiring Diagram Magnet - Control

Wiring Diagram Magnet Diagnostic and Temperature Sensors

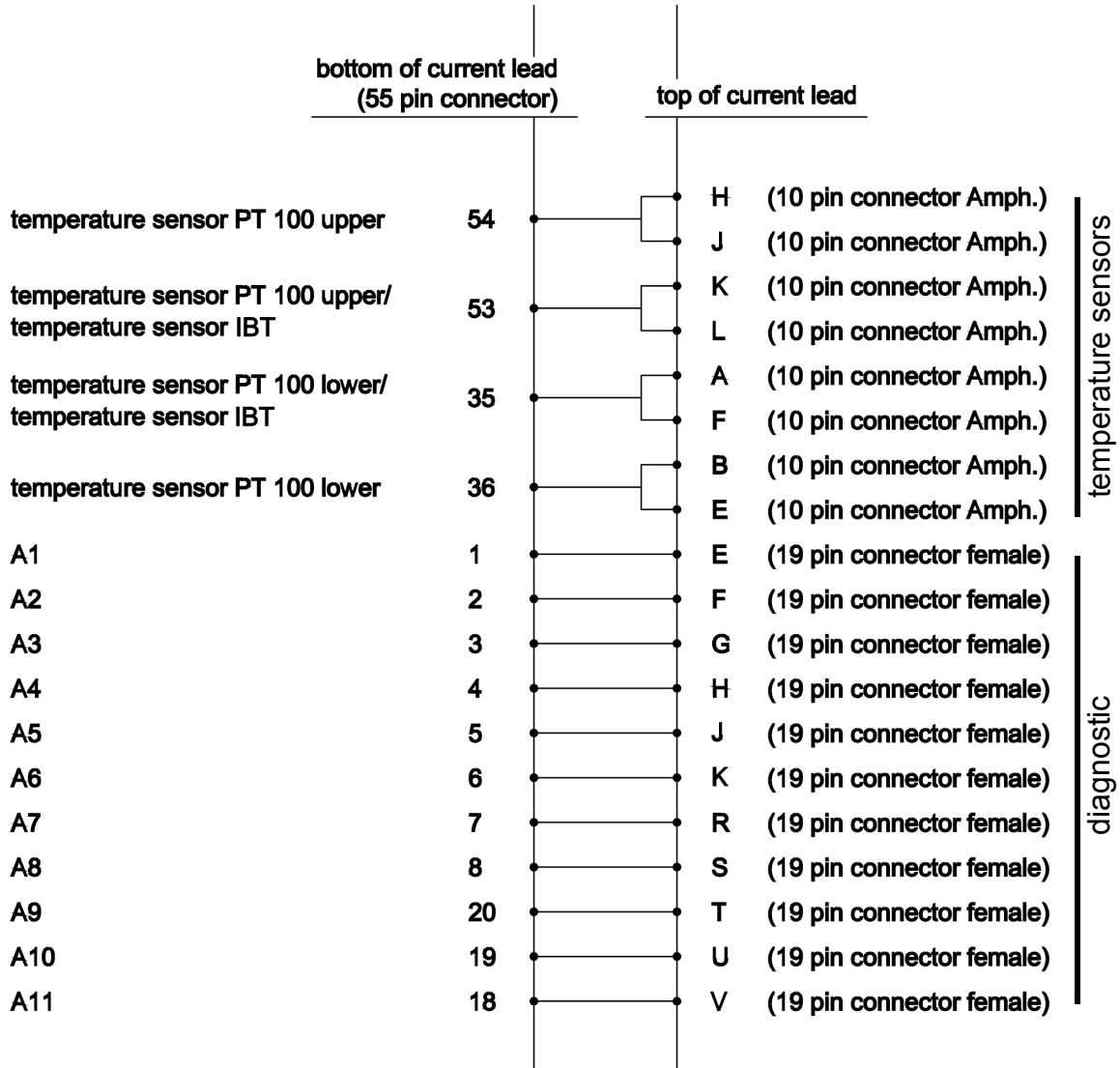

Z1029392

Figure A.13: Wiring Diagram Magnet - Diagnostic and Temperature Sensors

### Shorting Plug

The shorting plug is plugged after removal of the current lead. After inserting the shorting plug the current flows through the shorting plug and no longer through the current lead and the power supply.

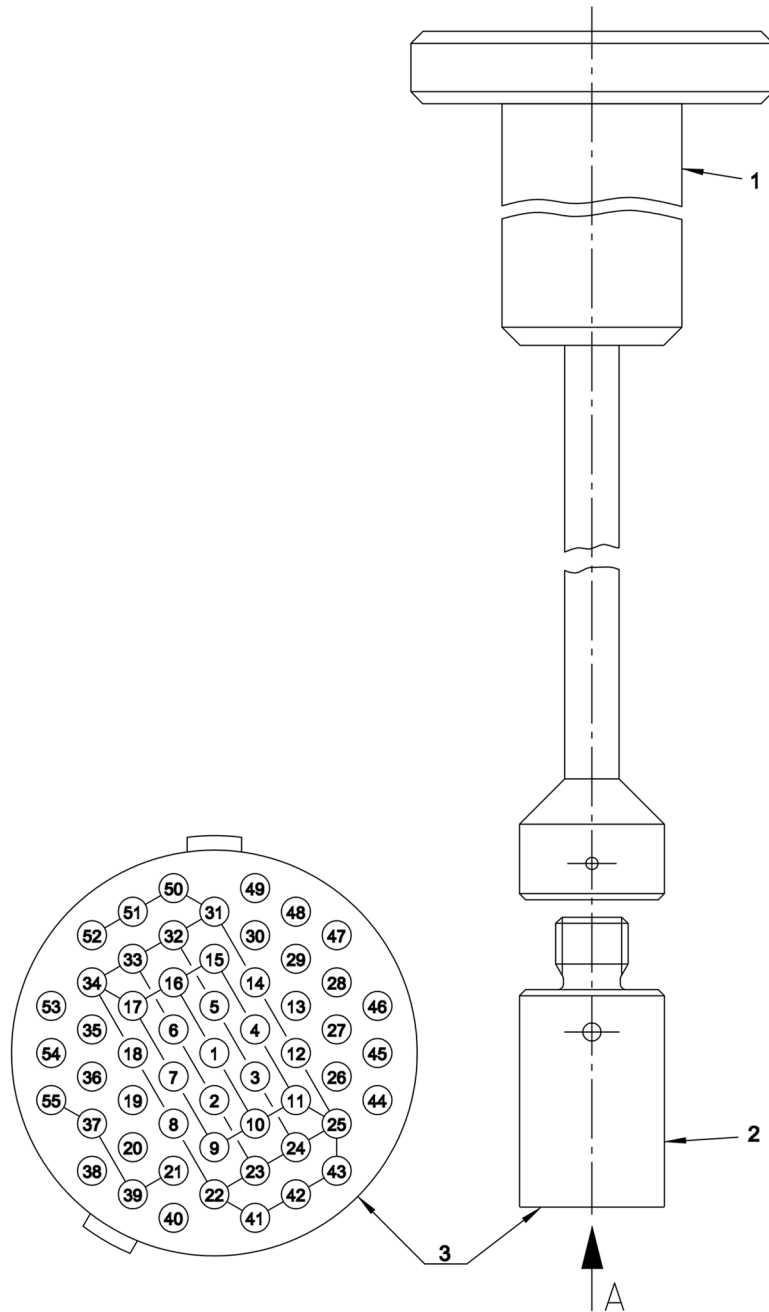

Z1029521

Figure A.14: Shorting Plug 55 pins

- 1 Shorting Plug Tool for fitting and removing the shorting plug
- 2 Shorting Plug
- 3 Shorting Plug - view from pin side

This page is intentionally left blank.

**Resistance at Room Temperature**

	Pin	Connector	Description	Value	Unit
From: To:	PIN V PIN S	19 PIN Con CONTROL 19 PIN Con CONTROL	Main Heater		Ω
From: To:	PIN D PIN S	19 PIN Con CONTROL 19 PIN Con CONTROL	Z Heater		Ω
From: To:	PIN G PIN S	19 PIN Con CONTROL 19 PIN Con CONTROL	X Heater		Ω
From: To:	PIN H PIN S	19 PIN Con CONTROL 19 PIN Con CONTROL	Y Heater		Ω
From: To:	PIN J PIN S	19 PIN Con CONTROL 19 PIN Con CONTROL	XZ Heater		Ω
From: To:	PIN K PIN S	19 PIN Con CONTROL 19 PIN Con CONTROL	YZ Heater		Ω
From: To:	PIN N PIN S	19 PIN Con CONTROL 19 PIN Con CONTROL	XY Heater		Ω
From: To:	PIN P PIN S	19 PIN Con CONTROL 19 PIN Con CONTROL	X <sup>2</sup> -Y <sup>2</sup> Heater		Ω
From: To:	PIN E PIN S	19 PIN Con CONTROL 19 PIN Con CONTROL	Z <sup>2</sup> Heater		Ω
From: To:	PIN F PIN S	19 PIN Con CONTROL 19 PIN Con CONTROL	Z <sup>3</sup> Heater		Ω
From: To:	PIN C,D,E,F PIN B,G,J,K	10 PIN Con SHIM 10 PIN Con SHIM	Shim Coils +/-		Ω
From: To:	+ PIN T	High current Con 19 PIN Con CONTROL	High Current to Sense +		Ω
From: To:	+ -	High current Con High current Con	Main Coil		Ω
From: To:	- PIN U	High current Con 19 PIN Con CONTROL	High Current to Sense -		Ω
From: To:	PIN T PIN U	19 PIN Con CONTROL 19 PIN Con CONTROL	Sense + Sense -		Ω
From: To:	PIN C PIN S	10 PIN Con SHIM 19 PIN Con CONTROL	Shim Coil to Heater (common)		Ω
From: To:	PIN C PIN T	10 PIN Con SHIM 19 PIN Con CONTROL	Shim Coil to Main Coil		Ω
From: To:	PIN T PIN S	19 PIN Con CONTROL 19 PIN Con CONTROL	Sense to Heater (common)		Ω
From: To:		All Connectors Ground	Insulation Magnet to Cryostat		Ω
From: To:	PIN K PIN H	10 Pin cool down Con 10 Pin cool down Con	Upper temperature sensor PT 100		Ω
From: To:	PIN A PIN K	10 Pin cool down Con 10 Pin cool down Con	IBT Carbon temperature sensor		Ω
From: To:	PIN A PIN B	10 Pin cool down Con 10 Pin cool down Con	Lower temperature sensor PT100		Ω

Table A.11: Resistance at Room Temperature

## Heater Currents



Heater Currents	Value	Unit
Main heater current		A
Shim heater current		A

Table A.12: Heater Currents

## Energizing Assignment and Currents

Check the "minimum level for energizing" (see page 75).

During energizing the Z<sup>2</sup> shim heater must be permanently ON.

Energizing Currents [A]			Sense voltage [mV]	Remarks Bruker Test Site
0	to			
	to			
	to			
	to			
	to			
<b>Overshoot (0.__% of final current)</b>				
	to	Overshoot	50	
<b>10 Minutes break at overshoot current</b>				
Overshoot	to	Final Current	50	
<b>Total energizing time [min]</b>				
<b>Rate of current ramp-down with magnet in persistent mode [A/min]</b>				
20				

Table A.13: Energizing Assignment and Currents

**Cycling Assignment and Shim Currents**  
 (recommended only for 500 MHz and more)

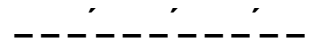

Cycling Assignment and Shim Currents	Value	Unit
Time between energizing and cycling		h
Time between cycling and shimming		h
Current rate		A/h
Z-Shim current		A
Z <sup>2</sup> -Shim current		A
Z <sup>3</sup> -Shim current		A
X-Shim current		A
Y-Shim current		A
XZ-Shim current		A
YZ-Shim current		A
XY-Shim current		A
X <sup>2</sup> -Y <sup>2</sup> -Shim current		A
Frequency change due to cycling		kHz
Date and Signature		

Table A.14: Cycling Assignment (recommended only for 500 Mhz and more)

**Energizing Currents**

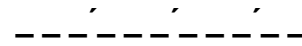

<b>Energizing Currents</b>	<b>Value Bruker Test Site</b>	<b>Value Customer Site #1</b>	<b>Value Customer Site #2</b>	<b>Unit</b>
Magnet main current				A
Z-Shim current				A
Z <sup>2</sup> -Shim current				A
Z <sup>3</sup> -Shim current				A
X-Shim current				A
Y-Shim current				A
XZ-Shim current				A
YZ-Shim current				A
XY-Shim current				A
X <sup>2</sup> -Y <sup>2</sup> -Shim current				A
Magnetic center from bottom flange (measured)				mm
Magnetic center from top flange (measured)				mm
Date and Signature				

Table A.15: Energizing Currents

**Deenergizing Assignment and Currents**

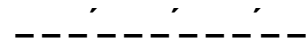

Deenergizing Currents [A]			Sense voltage [mV]	Remarks Bruker Test Site
	to	205	400	
205	to	190	1000	
190	to	0	2000	through external diodes
<b>Total deenergizing time [min]</b>				

Table A.16: Deenergizing Assignment and Currents

This page is intentionally left blank.









## A.6 Index

---

### A

Attachment Points ..... 32

### C

Cleaning Staff ..... 14

Complaint Process ..... 30

Cryogenic Agents ..... 18, 19

Cryostat ..... 12, 26

### D

Disturbances ..... 48

Drop-off Plate ..... 27

### E

Electricity ..... 19

Emergency ..... 28

Emergency Exit ..... 25

### F

Fire Department ..... 28

First Aid for Cold Burns ..... 28

### I

Identification Plate ..... 69

Intended Use ..... 16

### L

Liability ..... 11

Low Temperatures ..... 21

### M

Magnetic Field ..... 18

### O

One-way Valves ..... 27

### P

Portable Oxygen Monitor ..... 24

Protective Clothes .....	24
Protective Gloves .....	24
Protective Goggles .....	24

---

## Q

Quench .....	20, 53
Quench Valve .....	27

---

## R

Rescue Equipment .....	28
------------------------	----

---

## S

Safety Devices .....	26
Safety Shoes .....	24
Safety Valve .....	27
Shock Watch .....	30
Slippage .....	21
Spontaneous Ignition .....	21

---

## T

Tilt Watch .....	30
Tilting .....	22
Transportation .....	23

---

## W

Warranty .....	11
----------------	----

## Revision History List

<b>Index:</b>	<b>Date:</b>	<b>Alteration Type:</b>
00	September 2010	First version according to the specific form of the Corporate Guide Line and the definition from the Bruker documentation group and a new order of content.
01	April 2011	Update including nitrogen level sensor.
02	September 2012	Update and released fringe field data and related directives.

# Bruker, your solution partner

Bruker provides a world class, market leading range of analytical solutions for your molecular and material research needs. Our solution-oriented approach enables us to work closely with you to identify your specific needs and determine the best solution package for you from our comprehensive range. Furthermore, we offer you the opportunity to collaborate with us on new developments.

Our ongoing efforts and substantial investment in research and development demonstrate our long term commitment to technological innovation on behalf of our customers. With 50 years of experience in meeting the needs of the scientific community across a range of specialist disciplines, Bruker has built a sound rapport with professionals from the community through understanding specific requirements.

This cooperative relationship with our customers allows us to provide them with effective solutions and a service of unmatched quality.

---

 **Bruker Corporation**

info@bruker.com  
www.bruker.com