

minispec

- Sample Automation XYZ Sample Changer
User Manual
Version 002



Copyright © by Bruker Corporation

All rights reserved. No part of this publication may be reproduced, stored in a retrieval system, or transmitted, in any form, or by any means without the prior consent of the publisher. Product names used are trademarks or registered trademarks of their respective holders.

This manual was written by

Bruker BioSpin AIC

© June 17, 2015 Bruker Corporation

P/N: H148850

For further technical assistance for this product, please do not hesitate to contact your nearest BRUKER dealer or contact us directly at:

Bruker Corporation
Am Silberstreifen
76287 Rheinstetten
Germany
Phone: + 49 721 5161 0
FAX: + 49 721 5171 01
E-mail: minispec.SLS@bruker.com
Internet: www.bruker.com

Contents

1	About This Manual	5
1.1	Policy Statement	5
1.2	Symbols and Conventions	5
2	Introduction	7
2.1	Overview	7
2.1.1	Who Should Read This Book	7
2.2	Intended Use	7
2.3	Where to Go for More Information	7
3	Safety	9
3.1	Safety Notices	9
3.1.1	Power Cord Set Requirements	9
3.1.2	Power Cord Safety Maintenance	9
3.1.3	Mains Disconnect	9
3.1.4	Operating Environment	10
3.1.5	Mechanical Hazards	11
3.1.6	Explanation of Caution and Warning Notices	12
3.2	Electromagnetic Interference	13
3.3	Explanation of Regulatory Marks	13
4	Technical Data	15
4.1	Environmental Characteristics	15
4.2	Electrical Characteristics	15
4.2.1	Power Requirements	15
4.2.2	Data Connectors - Sample Changer	16
4.2.3	Data Connectors – Temperature Units	16
4.3	Pneumatic connections	16
5	Design and Function	17
5.1	Sample Changer Components	17
5.2	Additional Equipment Required	20
5.3	Optional Accessories	21
5.4	Chemical Compatibility	21
6	Transport, Packaging and Storage	23
7	Installation	25
7.1	Preparing for Installation	25
7.1.1	Choosing a Location	25
7.1.1.1	Space Requirements	26
7.1.1.2	Work Surface Requirements	26
7.1.1.3	Power Requirements	26
7.2	Installing the Temperature Units	27
7.3	Mounting the NMR Instrument	27
7.4	Connecting the E-Stop Button	27
7.4.1	Without the Safety Barrier	28

7.4.2	With the Safety Barrier.....	29
7.5	Connecting the Sample Changer to the Power Supply.....	29
7.6	Connecting the Sample Changer to the Host Computer.....	30
7.7	Establishing a USB Communications Interface	30
7.8	Establishing an RS-232 Serial Communications Interface	33
7.9	Verifying Installation.....	34
7.9.1	Aligning the Sample Changer	34
7.9.2	Testing the Gripper	34
8	Operation.....	35
8.1	Establishing Optimal Operating Conditions	35
8.1.1	Purchasing Supplies	36
8.2	Starting the Sample Changer.....	36
8.3	Stopping Sample Changer Movement.....	36
8.4	Shutting Down the Sample Changer.....	36
9	Maintenance.....	37
9.1	Cleaning the Sample Changer.....	37
9.1.1	Daily External Cleaning.....	37
9.1.2	Weekly Cleaning	38
9.2	Mounting the Z-Drive Assembly.....	38
9.2.1	Tools Required.....	38
9.2.2	Using Tubing Tamers.....	41
9.2.3	Connecting the Pneumatic Tubing.....	42
9.2.4	Connecting the Auxiliary Connector.....	42
10	Troubleshooting	45
10.1	Power System Problems.....	45
10.2	Communications Interface Problems	45
10.2.1	USB Cable Problems	46
10.3	Returning the Product for Service.....	46
10.3.1	Shipping the Product.....	46
11	Dismantling and Disposal.....	47
11.1	Safety.....	47
11.2	Dismantling	47
11.3	Disposal	48
12	Contact	49
13	Glossary	51
	List of Figures.....	53
	List of Tables	55
	Index	57

1 About This Manual

This manual is intended to be a reference guide for operators and service technicians. It provides detailed information about the user level maintenance and service, as well as overall use of the Bruker device.

This manual enables safe and efficient handling of the device.

This manual is an integral part of the device, and must be kept in close proximity to the device where it is permanently accessible to personnel. In addition, instructions concerning labor protection laws, operator regulations tools and supplies must be available and adhered to.

This manual is planned for use by the service engineer in the installation of the device or accessory, and for the user in performing existing experiments and for the setup of new experiments.

This manual is an integral part of the device, and must be kept in close proximity to the device where it is permanently accessible to personnel. In addition, instructions concerning labor protection laws, operator regulations tools and supplies must be available and adhered to.

Before starting any work, personnel must read the manual thoroughly and understand its contents. Compliance with all specified safety and operating instructions, as well as local work safety regulations, are vital to ensure safe operation.

The figures shown in this manual are designed to be general and informative and may not represent the specific Bruker model, component or software/firmware version you are working with. Options and accessories may or may not be illustrated in each figure.

1.1 Policy Statement

It is the policy of Bruker to improve products as new techniques and components become available. Bruker reserves the right to change specifications at any time.

Every effort has been made to avoid errors in text and figure presentation in this publication. In order to produce useful and appropriate documentation, we welcome your comments on this publication. Support engineers are advised to regularly check with Bruker for updated information.

Bruker is committed to providing customers with inventive, high quality products and services that are environmentally sound.

1.2 Symbols and Conventions

Safety instructions in this manual are marked with symbols. The safety instructions are introduced using indicative words which express the extent of the hazard.

In order to avoid accidents, personal injury or damage to property, always observe safety instructions and proceed with care.

DANGER



DANGER indicates a hazardous situation which, if not avoided, will result in death or serious injury.

This is the consequence of not following the warning.

1. This is the safety condition.
 - ▶ This is the safety instruction.

WARNING



WARNING indicates a hazardous situation, which, if not avoided, could result in death or serious injury.

This is the consequence of not following the warning.

1. This is the safety condition.
 - ▶ This is the safety instruction.

CAUTION



CAUTION indicates a hazardous situation, which, if not avoided, may result in minor or moderate injury or severe material or property damage.

This is the consequence of not following the warning.

1. This is the safety condition.
 - ▶ This is the safety instruction.

NOTICE

NOTICE indicates a property damage message.

This is the consequence of not following the notice.

1. This is a safety condition.
 - ▶ This is a safety instruction.

SAFETY INSTRUCTIONS

SAFETY INSTRUCTIONS are used for control flow and shutdowns in the event of an error or emergency.

This is the consequence of not following the safety instructions.

1. This is a safety condition.
 - ▶ This is a safety instruction.



This symbol highlights useful tips and recommendations as well as information designed to ensure efficient and smooth operation.

2 Introduction

2.1 Overview

The Sample Automation XYZ sample changer is designed to be sturdy, reliable, and easy to use. It provides automated temperature control and pick-and-place sample introduction for an analytical instrument such as an NMR spectrometer. The sample changer contains a microprocessor that allows sequential or random access to samples, providing flexibility.

The sample changer is typically interfaced to and controlled by the host computer using a USB or serial connection.

This document describes the procedures for installing, operating, and maintaining the sample changer. It also provides information about troubleshooting minor problems and describes the design of the sample changer.

2.1.1 Who Should Read This Book

The primary audience for this manual consists of analytical chemists and lab technicians. To use this manual effectively, you should have a basic knowledge of chemistry, a basic knowledge of electronic sampling equipment, at least a beginning level of computer experience, and working knowledge of other equipment used with the device.

 **WARNING****Chemical Injury Hazard**

The device is intended for use only by qualified operators who have been trained in safe laboratory practices. Make sure you know the hazards associated with all of the chemicals you are using, and take the appropriate precautions. Exposure to laboratory chemicals may result in serious injury.

2.2 Intended Use

The Sample Automation XYZ sample changer is designed for use as a temperature-controlled, pick-and-place automation system in analytical laboratories performing chemical analysis of samples.

2.3 Where to Go for More Information

For additional information on this and other products refer to the BRUKER:

www.bruker.com.

3 Safety

Review this product and related documentation to become familiar with safety markings and instructions before you operate the device.

3.1 Safety Notices



CAUTION

Injury Hazard

If the device is used in a manner not specified by the manufacturer, the protection provided by the device may be impaired.

Any repair or service that is not covered in this manual should only be performed by qualified personnel.

3.1.1 Power Cord Set Requirements

The power cord set supplied with the device meets the requirements of the country where the device was purchased. Power is supplied to the device through the included 24V power supply.

3.1.2 Power Cord Safety Maintenance

The operator should check the condition of the power/signal supply cord. The device should not be operated if the mains inlet is cracked or broken. Any obvious damage to the case (from a drop or fall) should be checked by service personnel for loose or damaged parts. Refer to the individual part lists, or contact Bruker, for approved replacement parts.

3.1.3 Mains Disconnect

The power switch on the rear panel is not the mains disconnect. Power mains disconnect is accomplished by unplugging the power cord from the power supply or from the wall outlet. Ensure the power cord is easily accessible and removable, in the event of an emergency which requires immediate disconnection.

WARNING



Fire and Shock Hazard

Incorrect installation or use of the power supply may result in a fire or shock hazard.

- ▶ Use only the provided power supply.
- ▶ The power supply must be plugged into an outlet which has a protective ground connection.
- ▶ Ensure that the power cord is disconnected before removing any covers.

3.1.4 Operating Environment

WARNING



Shock Hazard from Rain or Humidity

Device exposure to rain or humidity could result in a risk of fire or electrical shock.

- ▶ Do not expose the device to rain or humidity.
- ▶ Do not open the cabinet, all maintenance is to be performed by an authorized service provider.

Protection provided by the device may be impaired if the device is used in a manner not specified by the manufacturer.

WARNING



Shock Hazard from Liquids

Liquid coming in contact with electrical components may result in a serious injury through shock.

- ▶ Do not allow any liquid to enter the device cabinet other than as intended through the specified tubing, or come into contact with any electrical components.
- ▶ The device must be thoroughly dry before you reconnect power, or turn the device on.

WARNING



Explosion Hazard

Explosive atmospheres caused by flammable gases, mists or vapors or by combustible dusts could result in an explosion.

- ▶ Prevent the release of dangerous substances, which can create explosive atmospheres.
- ▶ Prevent sources of ignition.
- ▶ Do not operate the device in an explosive atmosphere.

WARNING



Chemical Hazards

Incorrect use of chemicals used in and near the device may result in injury or property damage.

- ▶ Learn about the chemicals which will be used in and near the device, and observe the necessary precautions.
- ▶ Always use appropriate personal protective equipment, including protective eyewear.

3.1.5 Mechanical Hazards

If you insert any part of your body between the moving parts of the device, you could be injured. The figure below shows the location of potential hazards:

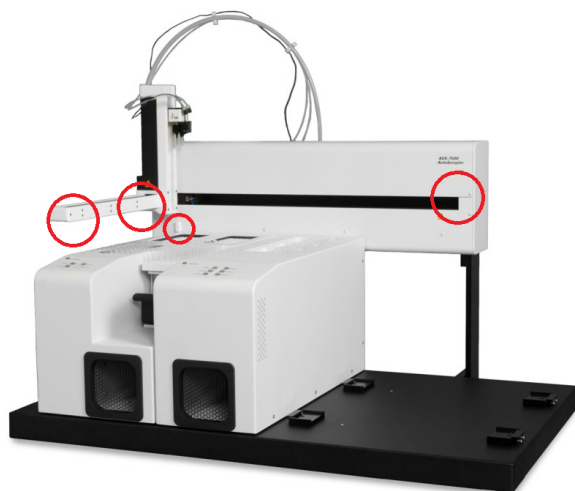

Figure 3.1: Overview of the Mechanical Hazards (Without Optional Safety Barrier)

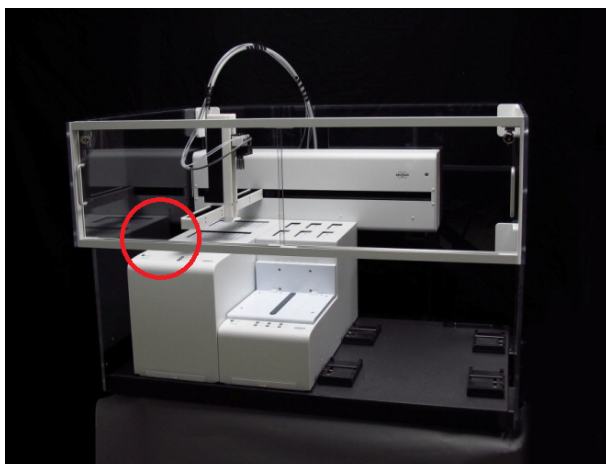

Figure 3.2: Overview of the Mechanical Hazards (With Optional Safety Barrier)



WARNING

Pinch Hazard

Keep fingers, hair, and loose clothing away from the moving parts of the device.



WARNING

Pinch/Puncture Hazard

Ensure the AC power is off before proceeding with installation. If the power is left on, motors may move unexpectedly and cause injury.

3.1.6 Explanation of Caution and Warning Notices



	<p>Warning symbol marked on device.</p> <ul style="list-style-type: none"> • This symbol means "Attention! Refer to the manual."
	<p>Crush Hazard / Pinch Point.</p> <ul style="list-style-type: none"> • Keep hands clear of moving parts. X, Y, Z axis movement may crush hand.
	<p>Puncture Hazard – Moving parts can cause severe injury.</p> <ul style="list-style-type: none"> • Do not put hand under the gripper assembly!
	<p>Lifting Hazard – Single person lift could cause injury.</p> <ul style="list-style-type: none"> • Use assistance when moving or lifting.

Table 3.1: Explanation of Caution and Warning Notices

3.2 Electromagnetic Interference

FEDERAL COMMUNICATIONS COMMISSION (FCC) NOTICE

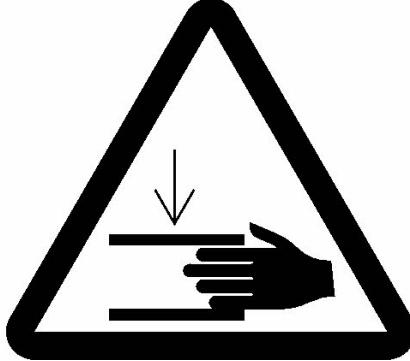
This equipment has been tested and found to comply with the limits for a Class A digital device, pursuant to Part 15 of the FCC Rules. These limits are designed to provide reasonable protection against harmful interference in a commercial installation.

This equipment generates, uses, and can radiate radio frequency energy and, if not installed and used in accordance with the instructions, may cause harmful interference to radio communications. Operation of this equipment in a residential environment is likely to cause harmful interference, in which case the user will be required to correct the interference at his expense.

MODIFICATIONS

The FCC requires the user to be notified that any changes or modifications made to this device that are not expressly approved by the manufacturer may void the user's authority to operate the equipment.

CABLES

Connections to this device must be made with shielded cables with metallic RFI/EMI connector hoods to maintain compliance with FCC Rules and Regulations.

CANADIAN NOTICE

This digital apparatus does not exceed the Class A limits for radio noise emissions from digital apparatus as set out in the interference-causing equipment standard entitled "Digital Apparatus" ICES-001 of the Department of Communications.

AVIS CANADIEN

Cet appareil numérique respecte les limites de bruits radioélectriques applicables aux appareils numériques de Classe A prescrites dans la norme sur le matériel brouilleur: "Appareils Numériques," NMB-001 édictée par le ministre des Communications.

3.3 Explanation of Regulatory Marks



The CE mark is a registered trademark of the European Community. This CE mark shows that the product complies with all the relevant European Legal Directives.

4 Technical Data

4.1 Environmental Characteristics

These environmental characteristics indicate the conditions for safe operation. Instrument performance may depend on the ambient conditions.

Operating Temperature	+5° C to +40° C (+41° F to +104° F)
Non-Operating Temperature	+0° C to +55° C (+32° to +131° F)
Operating Altitude	Up to 2,000 m (6,562 ft.)
Relative Humidity	0% to 80% non-condensing for temperatures up to 31° C, decreasing linearly to 50% at 40° C.
Non-Operating Relative Humidity	0% to 95% non-condensing.
Pollution Degree	Pollution degree 2. Normally no pollution or only dry, non-conductive pollution occurs. The pollution has no influence. Occasionally, however, a temporary conductivity caused by condensation may be expected.

Table 4.1: Environmental Characteristics

For indoor use only.

Avoid sudden, extreme temperature changes which could cause condensation on circuit boards in the device.

See also

 Establishing Optimal Operating Conditions [[▶ 35](#)]

4.2 Electrical Characteristics

4.2.1 Power Requirements

Power Supply	Input: AC Voltage, Frequency, and Current 100-240 V ~ 47-63 Hz 1.07 A Installation Category: CAT II (Line voltage in appliance and to wall outlet) Output: 24 V DC, 3.33 A
--------------	---

Sample Changer	Input: DC Voltage and Current 24 V 3.33 A Installation Category: CAT I (Mains isolated) Use only with the provided power supply.
----------------	--

Table 4.2: Power Requirements

4.2.2 Data Connectors - Sample Changer

Note that the USB and COM connectors on the sample changer cannot be used at the same time.

COM 1	DB-9 RS-232 serial connection to a controller PC (max ±12V DC, 8 mA).
COM 2	DB-9 RS-232 serial connection to accessories or instruments (max ±12V DC, 8 mA).
USB	USB connection to a controller PC (max 5V DC).
ETHERNET	Ethernet connection (disabled by default. Max 5V DC).
Z-DRIVE	15-pin power and signal connection for Z-drive. 24V max output. Connect only to the supplied Z-drive, using the cable which is part of the Z-drive.
AUXILIARY	Controls the gripper. Use only with the provided gripper or as instructed by the manufacturer (max 24V).

Table 4.3: Data Connectors on the Sample Changer

4.2.3 Data Connectors – Temperature Units

COM 1	DB-9 RS-232 serial connection to a controller PC (max. ±12V DC, 8 mA).
RS-485	RS-485 serial connection to other temperature unit (max. 5V DC).

Table 4.4: Data Connectors - Temperature Units

4.3 Pneumatic connections

Two pneumatic fittings provide air flow to power the gripper. The maximum pressure is 207 kPa (2 bar, 30 psi).

5 Design and Function

5.1 Sample Changer Components

The following components are located on the front of the sample changer and are shipped with the sample changer .



Figure 5.1: Sample Automation XYZ Sample Changer—Front View with TC3 (10 mm SFC Version), TC6 and MFC Analyzer

1	Arm. The arm moves the gripper horizontally
2	Z-Drive Assembly. The Z-Drive assembly moves the gripper vertically. The assembly includes a Z-Axis motor assembly as well as the gripper mounting bracket. The Z-Drive motor assembly attaches onto the sample changer arm.
3	Gripper Assembly. The pneumatic gripper assembly moves vials between the temperature units and the instrument.
4	Sample Changer Head. The sample changer head contains electronics for the sample changer and supports the sample changer arm.
5	Power Indicator Lamp. The LED indicates that the sample changer is connected to a power source and turned on.
6	NMR Instrument.
7	Waste Chute. The sample changer can drop used vials here for disposal.
8	Base. The temperature units and the NMR instrument attach securely to the base of the sample changer.
9	

9 **Temperature Units.** The temperature units each have several temperature zones which heat or cool the samples.

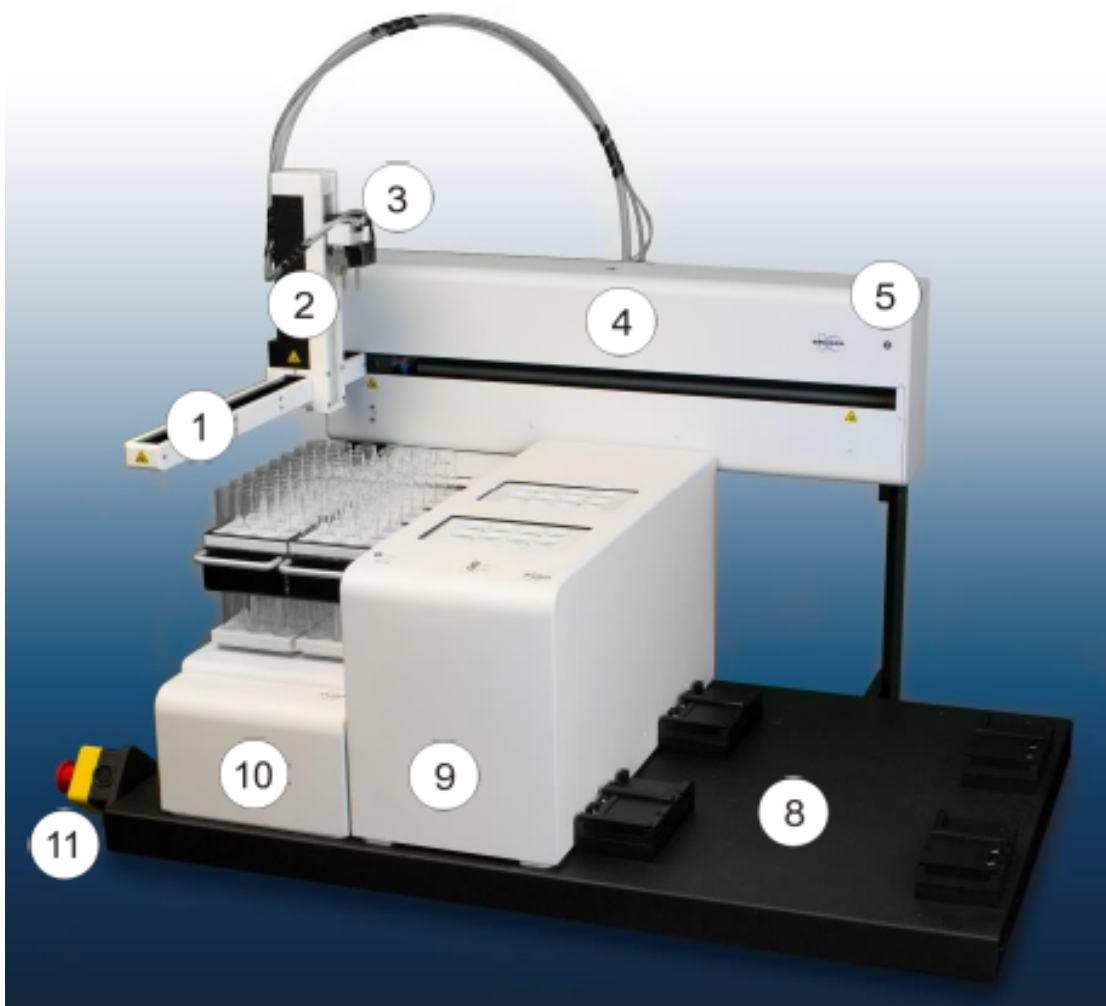

Figure 5.2: Sample Automation XYZ Sample Changer—Front View with TC3 (2 Zone 26 mm Version) and Sample Stage

1	Arm. The arm moves the gripper horizontally
2	Z-Drive Assembly. The Z-Drive assembly moves the gripper vertically. The assembly includes a Z-Axis motor assembly as well as the gripper mounting bracket. The Z-Drive motor assembly attaches onto the sample changer arm.
3	Gripper Assembly. The pneumatic gripper assembly moves vials between the temperature units and the instrument.
4	Sample Changer Head. The sample changer head contains electronics for the sample changer and supports the sample changer arm.
5	Power Indicator Lamp. The LED indicates that the sample changer is connected to a power source and turned on.
8	Base. The temperature units and the NMR instrument attach securely to the base of the sample changer.
9	Temperature Units. The temperature units each have several temperature zones which heat or cool the samples.
10	Sample Stage. Holds samples without temperature control.
11	E-Stop Button. Immediately halts motion in case of emergency.

The following components are located on the back of the sample changer and are shipped with the sample changer:

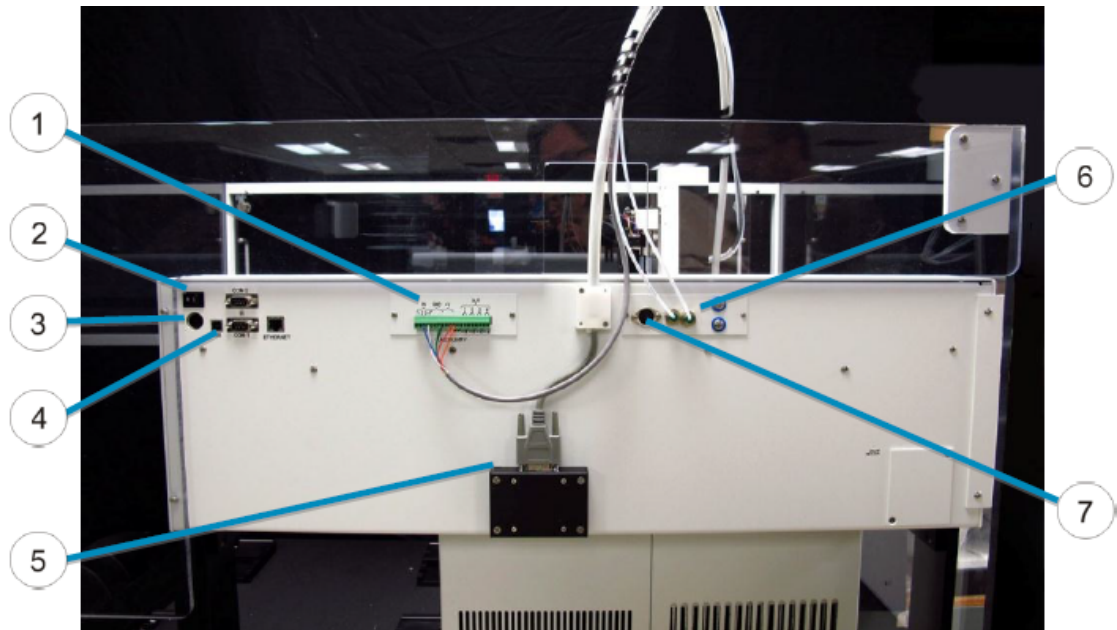

Figure 5.3: Sample Automation XYZ Sample Changer—Back View of Sample Changer Head.

1	Auxiliary I/O Port. Provides control signals to the gripper.
2	Power Switch. This switch turns the power to the sample changer on and off.
3	Power Supply Connector. The power supply connects to the sample changer at this connector.
4	USB Port. The USB port is used to interface the sample changer with the host computer.
5	Z-Drive Connector. The Z-drive contains an integral motor and lead screw, and is powered and controlled through a connector on the back of the sample changer.
6	Gripper Tubing Fittings. An internal pump generates air flow to power the pneumatic gripper head.
7	E-Stop Connector. Connector for the emergency stop button.

The following standard components are also shipped with the sample changer:

- **Power Supply.** A desktop power supply powers the sample changer.
- **Communication Cable.** The kit includes a USB cable.
- **E-stop button.** The e-stop button can be mounted on the outside of the safety barrier to make it easy to quickly stop sample changer movement.

5.2 Additional Equipment Required

In addition to the equipment provided, you will need:

- A host computer with an available USB or serial port.
- NMR or other analytical instrument.
- **Sample Stage.** Holds two racks and standards. Used with 10 mm and 26 mm systems.
- **Temperature Units.** The sample changer is typically used with two temperature units (sold separately):
 - **TC3 Temperature Unit.** One, two, or three discrete ones hold samples at a fixed temperature.
 - **TC6 Temperature Unit.** Each of the six zones can hold 10 samples at a user-defined temperature.



Figure 5.4: TC3 and TC6 Temperature Units.

5.3 Optional Accessories

The following optional accessories are available:

- **Safety barrier.** The optional safety barrier reduces the possibility of a person or other objects coming in contact with the moving arm and gripper of the sample changer.
- **Balance adapter kit.** Allows a laboratory balance to be integrated on the rear of the sample stage.

5.4 Chemical Compatibility

Sample changer components are made of corrosion-resistant stainless steel alloys or anodized aluminum. The enclosure and base are made from a high-strength aluminum alloy that is treated with a RoHS-compliant Chem Film and finished with an epoxy powder coating.

The sample changer operates reliably under a wide variety of conditions. Wetted components are made of Polyetherimide (PEI) and Polytetrafluoroethylene (PTFE) and can withstand repeated exposure to oils and common organic solvents such as acetone and alcohols.

6 Transport, Packaging and Storage

WARNING



Lifting Hazard

Lifting without assistance may cause injury.

- ▶ Two people are required to lift the device.
- ▶ Lifting should be done with a person situated on either side of the device.

Upon receipt of the device, inspect external packaging for signs of shipping damage. Inspect all items during unpacking and notify the carrier immediately of any concealed damage. Check for any kinked tubing.

If the system is shipped or removed from storage during cold weather, allow the packaged equipment to equilibrate to room temperature before opening and exposing to warm, humid air. It is usually sufficient to provide four to eight hours for this purpose.

CAUTION



Equipment Damage from Condensation

If condensation forms on or inside the device, allow it to dry thoroughly before connecting it to a power source and operating it. Failure to do so may cause equipment damage.

Remove the packing checklist from the shipping container, and check off items against it. Leave accessories in the packing until you are ready to install them.



Note: Keep the factory packaging for use in case the product ever needs to be returned or shipped to another location.

7 Installation

Installation consists of the following steps:

1. Attach the Z-drive and assemble the sample changer.
2. Attach the enclosure back, if purchased.
3. Place the sample changer in its final position.
4. Mount the temperature units.
5. Mount the NMR instrument.
6. Connect the cables between the temperature units and the sample changer.
7. Connect the system to the host PC.
8. Power on the system.

WARNING



Lifting Hazard

Lifting without assistance may cause injury.

- ▶ Two people are required to lift the device.
- ▶ Lifting should be done with a person situated on either side of the device.

WARNING



Pinch/Puncture Hazard

Ensure the AC power is off before proceeding with installation. If the power is left on, motors may move unexpectedly and cause injury.

7.1 Preparing for Installation

Installing the sample changer requires preparation. Before you install the sample changer, you should evaluate the physical arrangement of the laboratory to choose a suitable location. Once you choose a location, you must carefully unpack the sample changer prior to beginning the installation.

This section discusses what requirements must be met when you choose a location.

7.1.1 Choosing a Location

Choosing a location for the sample changer involves evaluating the lab environment for the availability of space, waste disposal, and power. For the system to function optimally, the location you select must meet specific requirements associated with each of these items. The following sections discuss space, work surface, and power requirements. The documentation for the NMR instrument may provide additional guidance.

7.1.1.1 Space Requirements

The recommended footprint for Sample Automation XYZ sample changer (with or without optional enclosure) is shown in the following table.

	Recommended Space Including Cables/Tubing
Height	1 m (23.0")
Width	113 cm (41.0")
Depth	1 m (31.0")

Table 7.1: Physical Characteristics

Allow at least 10 cm behind the device for cable egress, ventilation, and access to the power switches. Always position the device so that it is easy to disconnect the power cord.

7.1.1.2 Work Surface Requirements

The device must be placed on a very sturdy countertop or table. Do not place the device on a wheeled cart or folding table. During operation, the device produces both vertical and horizontal forces. The work surface must support the equipment without shaking or wobbling.

7.1.1.3 Power Requirements

The sample changer receives power through the connection to the external power supply. Place the sample changer within 1.2 meters of a power outlet.

WARNING

Fire and Shock Hazard

Incorrect installation or use of the power supply may result in a fire or shock hazard.

- ▶ Use only the provided power supply.
- ▶ The power supply must be plugged into an outlet which has a protective ground connection.
- ▶ Ensure that the power cord is disconnected before removing any covers.

The sample changer is intended to operate from DC power supplied through the provided power supply. The power supply is provided power through an AC power source that will not apply more than 240VAC between the supply conductors and ground. A protective ground connection, by way of the grounding connector in the power cord, is required for safe operation.

Ensure that you position the sample changer so that the location where the power supply cord plugs into it is easily accessible (is not blocked) and it can be quickly disconnected if needed. In case of hazard, the sample changer should be disconnected from the power source.

The power supply socket is on the back of the sample changer below the power switch. Connect the power supply to the sample changer first and then connect a line cord to the power supply. Do not apply power to the power supply until ready to operate the sample changer.

Additional outlets will be needed for the temperature units and for the NMR instrument.

7.2 Installing the Temperature Units

Each temperature unit comes with a manual which explains how to mount it on the sample changer and how to connect the cables.

7.3 Mounting the NMR Instrument

- Place the sample changer in its final operating position.
Once the NMR instrument is mounted, the sample changer will be too heavy to move without a mechanical lift.
- Loosen the screws in the two mounting brackets and pull the clamp outward.

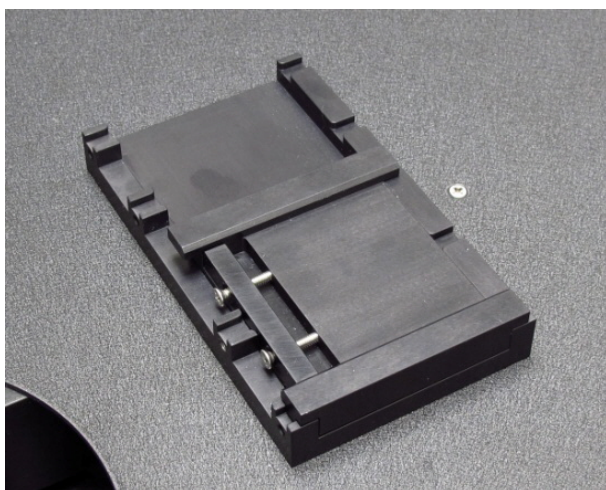

Figure 7.1: Mounting Bracket

- With the help of an assistant, carefully lower the instrument so that the mounting bars on the bottom of the instrument rest in the mounting brackets.
- Tighten the screws.
- See the instrument manual for information on connecting and using the instrument.

7.4 Connecting the E-Stop Button

The e-stop button makes it easy to quickly stop all movement without reaching behind the instrument. The e-stop button can be mounted on the side of the instrument or on the outside of the optional safety barrier.

7.4.1 Without the Safety Barrier

- Decide whether to mount the button on the left or right side of the instrument.
- Use the two included screws to attach the bracket to the side of the base.



Figure 7.2: E-Stop Shown on Left Side of the Base

- Open the button enclosure.
- Insert the two mounting screws through the back of the button and through the holes in the bracket.

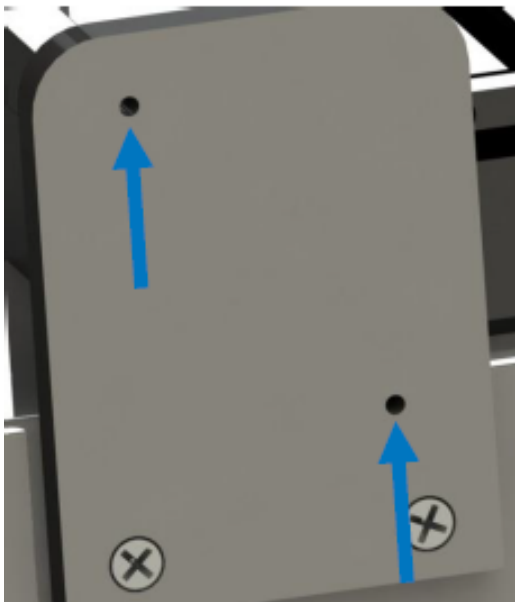

Figure 7.3: Location of Holes in the Bracket

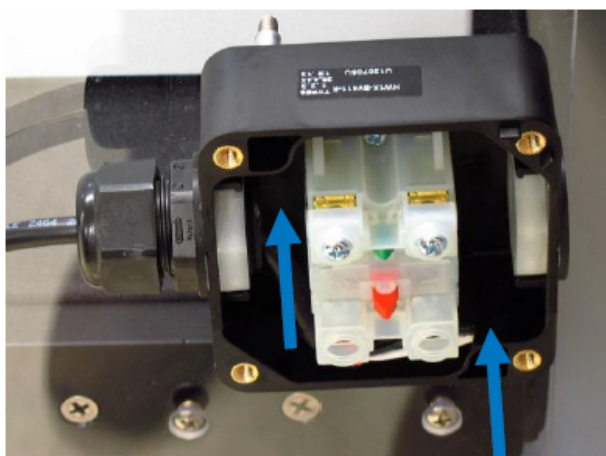

Figure 7.4: Location of Mounting Screws

- Install the two nuts on the mounting screws.



Figure 7.5: Rear View of E-Stop After Mounting (Shown mounted to safety barrier so that screw locations are more visible)

- Replace the front of the button enclosure.
- Connect the button to the back of the sample changer.

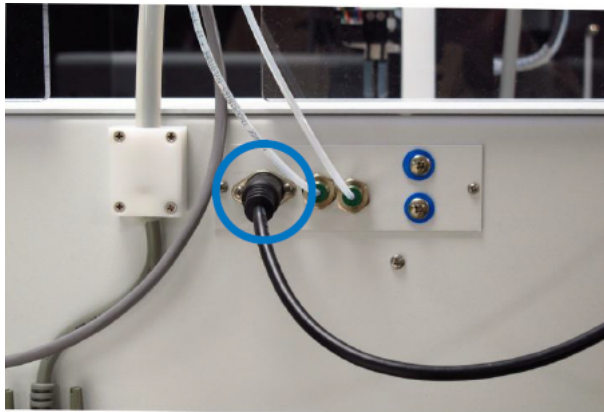

Figure 7.6: E-stop Connected to the Sample Changer

7.4.2 With the Safety Barrier

The e-stop button is installed when the safety barrier is assembled. See the *Safety Barrier Assembly Quick Installation Guide*.

Connect the button to the back of the sample changer. See the figure above.

See also

- Without the Safety Barrier [▶ 28]

7.5 Connecting the Sample Changer to the Power Supply

- Turn the sample changer power switch OFF.
- Check the plug on the power cord to verify that it is of the correct type for your country.
- Plug the power cord into a power outlet.
- Plug the power cord into the power supply.
- Plug the power supply into the 24V connector on the sample changer.
- Turn the power switch on the sample changer ON.

It is important to use the appropriate power cord for your geographical location. See:

[Power requirements](#) [▶ 15].

[Power Cord Set Requirements](#) [▶ 9].

WARNING



Fire and Shock Hazard

Incorrect installation or use of the power supply may result in a fire or shock hazard.

- ▶ Use only the provided power supply.
- ▶ The power supply must be plugged into an outlet which has a protective ground connection.
- ▶ Ensure that the power cord is disconnected before removing any covers.

See also

 [Electrical Characteristics](#) [▶ 15]

7.6 Connecting the Sample Changer to the Host Computer

Instrument control software on the host computer controls both the NMR instrument and the sample changer. You cannot operate the sample changer until you establish a communications interface between the sample changer and the host computer. It is through this interface that the host computer directs the operation of the sample changer. The sample changer supports the following communications protocols:

- The USB interface is the standard configuration. A virtual COM port is created when using the USB, and therefore the connection looks like a standard RS-232 serial port to the host PC software.
- The serial (RS-232) protocol is also a supported configuration. There are two RS-232 serial ports on the sample changer, and a serial interface kit may optionally be shipped with the sample changer.

7.7 Establishing a USB Communications Interface

A USB cable is supplied. Alternatively, any “A-B” USB cable may be used.

- Power up both the computer and the sample changer.
- Plug one end of the cable into the host computer's USB port and the other end to the sample changer's USB port.

The computer screen should display a "New Hardware Found" window. A USB driver must be installed to make the USB port emulate an RS-232 COM port, and the installation must be repeated for each USB connection.

The exact procedure for installing the driver depends on the version of the host computer's operating system. The instructions which follow show installation on the Windows XP operating system.

- Allow the Windows Found New Hardware Wizard to use Windows Update to search for a driver.

In most cases, the driver will be found online and installed automatically. This process may take several minutes.

- If a driver is not found, click **Back** and install the drivers from the supplied installation media.

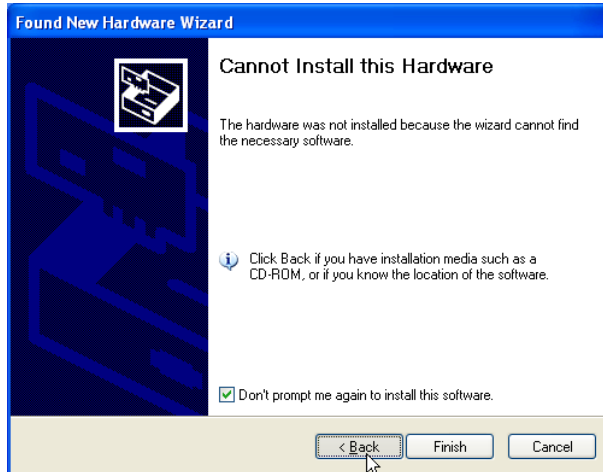

Figure 7.7: Message showing that a driver was not found.

- Insert the installation media, if necessary.
- Select **Install** from a specific location and click **Next**.

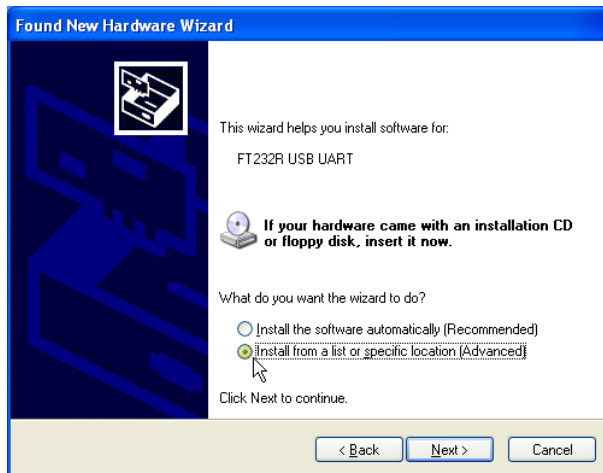

Figure 7.8: Choosing to install USB driver

- Select **Search removable media**.

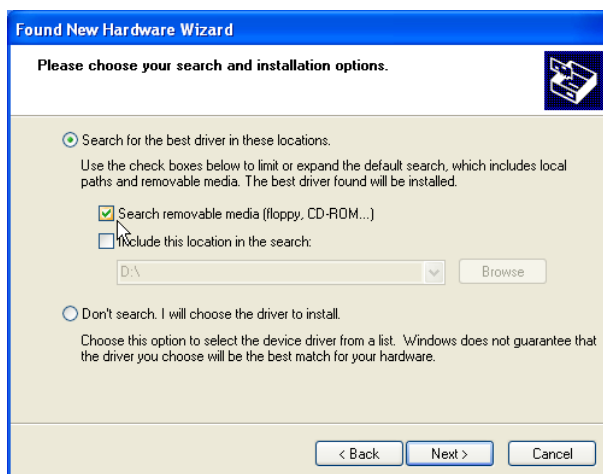

Figure 7.9: Choosing to install USB driver from a removable media

- Wait while the computer searches the media.

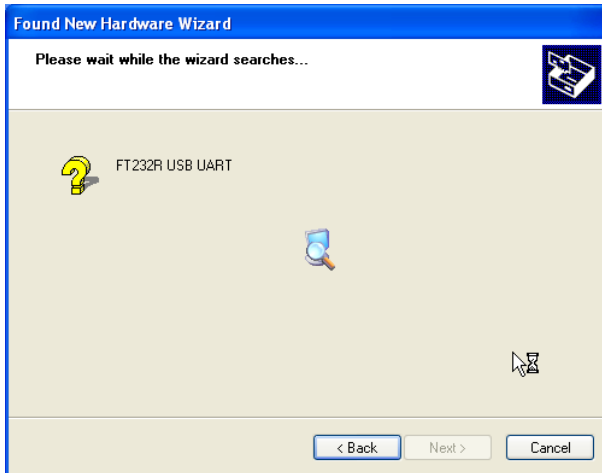

Figure 7.10: Searching for the driver

- When the driver is found, select it and click **Next**.

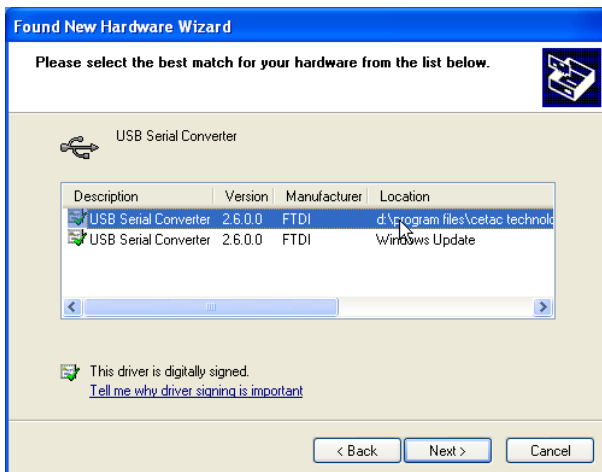

Figure 7.11: Selecting the driver

- The driver installation is complete.



Figure 7.12: Driver installation is complete

- If a message is displayed showing which COM port number was selected (look for a “bubble” in the lower-right corner of the screen), make a note of it.
- Confirm that the COM port selected for the USB matches the port selected in the host computer's instrument control software.

7.8 Establishing an RS-232 Serial Communications Interface

Use the provided serial cable to connect the host computer to the sample changer.

- Plug one end of the cable into the host computer's serial (COM) port selected for sample changer communications.
- Finger-tighten both screws of the connector.
- Connect the other end of the cable to the sample changer's COM1 port.
- Finger-tighten both screws of the connector.

Notes

If a host computer serial port with a DB9F, a DB25M, or a DB25F connector (9 pin D-subminiature receptacle or 25 pin D-subminiature plug or receptacle) must be used, use the mating connector from the universal port adapter kit. You can order the adapter kit from Bruker or purchase an adapter locally to convert the serial port to a DB9M. **Do not use a “null modem” adapter.**

Ensure you are connecting the adapter to the COM1 port. Connecting the adapter to the COM1 port on the sample changer will cause a malfunction. The sample changer COM2 port is used for communication with the temperature units.

When interconnecting any computing devices, keep the communications cables away from sources of electromagnetic or radio frequency (RF) interference, such as electric motors, transformers, fluorescent light ballasts, or RF energy sources. Limit cable runs for RS-232C to less than 16 meters. If these conditions cannot be satisfied, use low-impedance, fully shielded cables to provide satisfactory operation. The cables are available from many sources, but you will need to specify the correct mating connectors and “straight-through” (DTE-DCE) wiring.

7.9 Verifying Installation

Once installation of the sample changer is complete, it is important to verify that you have installed it correctly. Attempting to use it before ensuring that it is installed correctly may result in damage to the sample changer.

The gripper must align with each sample vial to ensure satisfactory analysis. Shipping or rough handling can disturb the sample changer's cabinet-to-base alignment. If it is incorrectly aligned, the gripper will not function properly. It is therefore important to perform testing before you actually run the sample changer.

7.9.1 Aligning the Sample Changer



Note: Before alignment, ensure that you have installed all sample changer components correctly. Also, ensure that you have securely tightened all thumbscrews and connected the communications cable from the host computer to the sample changer.

You will need the following items:

- Alignment probe.
- Alignment puck inserts.
- A PC with the ASX-7000 alignment utility.

Refer to the alignment guide or the online help within the alignment software for instructions.

7.9.2 Testing the Gripper

Once the sample changer has been aligned, test it with empty sample vials.

- Load the sample changer with empty sample vials at the positions you wish to test.
- Turn the sample changer power switch on and verify that the LED power indicator is on.
- Command the sample changer to move the gripper to sample positions at each of the corners of the sample zones. Check that the gripper correctly accesses each position.

See also

- 📄 [Installing the Temperature Units \[▶ 27\]](#)

8 Operation

Before using the sample changer, ensure that your lab environment provides operating conditions that will prolong the life of the sample changer. Once the proper operating conditions are met, you can load samples and start the sample changer sequence run.

8.1 Establishing Optimal Operating Conditions

The sample changer operates reliably even under less than ideal conditions. It is not, however, indestructible. Malfunction or damage can occur if specific operating conditions are not met. Meeting these conditions requires that you create the proper lab environment, replace sample changer components that wear out under normal use, and purchase the appropriate supplies for use with the sample changer. The following sections explain how to meet these conditions.



Note: Damage or malfunction that results from unsatisfactory operating conditions may constitute misuse and abuse and be excluded from warranty coverage.

To create satisfactory operating conditions in your lab environment, follow these guidelines:

- Operate the system in a conventional lab environment where the temperature does not exceed 80 °F (26 °C), the system is not exposed to condensing humidity, and the system is not exposed to excessive flammable or corrosive materials.
- Avoid rough handling of the sample changer. If possible, do not expose the sample changer to vibration or shock.
- Protect the sample changer from long-term exposure to condensation, corrosive materials, solvent vapor, continual standing liquids, or large spills into the sample changer cabinet or arm. Exposures of this type can damage the drive mechanisms as well as the electronics.
- Observe the same general electrostatic discharge precautions as with any other integrated circuit electronic devices. Low humidity environments, especially when combined with static-generating materials, require maximum care.



CAUTION

Static Discharge Buildup Hazard

Discharge static buildup and ground to the device cabinet before performing any maintenance. Do not touch or short-circuit any electrical connectors.

- Avoid using the sample changer if strong electromagnetic interference, radio frequency interference, or radioactivity is present. Interference fields can cause erratic operation of the sample changer. The sample changer will not function properly if the level of radioactivity is above background.

8.1.1 Purchasing Supplies

Because the life-span of the sample vials varies, you should maintain an adequate supply of spare vials. When you need to purchase additional supplies, it is extremely important that you choose the appropriate sizes and materials.

When you purchase sample vials, make sure they meet the following requirements:

- The diameter of the vial matches the rack size you are using.
- The height provides sufficient clearance below the gripper.
- The material is compatible with the samples you are analyzing.



CAUTION

Hazard from Mismatched Sample Vials

Use of mismatched sample vials may result in malfunctions or sample spills. Be sure your vials meet the given requirements.

8.2 Starting the Sample Changer

Once you arrange the samples are loaded, you can start the sample changer and let it run until the sampling sequence is finished.



WARNING

Pinch Hazard

Keep fingers, hair, and loose clothing away from the moving parts of the device.

- Turn the sample changer power switch on.
The LED power indicator along the sample changer X-Axis lights up when the power is on.
- Access the host computer's software and activate the sample changer program.
The sample changer runs until it reaches the end of the sampling sequence.

8.3 Stopping Sample Changer Movement

In the event of an emergency:

- Press the red **E-stop** button to stop sample changer movement.

8.4 Shutting Down the Sample Changer

To shut down the sample changer, complete the following steps:

- Turn off the sample changer power switch.
- If you will be performing maintenance, unplug the power cord either at the power supply or at the wall outlet.

9 Maintenance

Routine maintenance of the sample changer consists of daily and weekly cleaning of specific sample changer components. Routine maintenance also includes checking for leaks or other damage.



CAUTION

Static Discharge Buildup Hazard

Discharge static buildup and ground to the device cabinet before performing any maintenance. Do not touch or short-circuit any electrical connectors.

9.1 Cleaning the Sample Changer

Cleaning the sample changer is the primary maintenance task you perform. Failure to do so regularly causes increased wear and reduces the sample changer's life.

You must clean the sample changer both daily and weekly to prevent damage and extend its life. It is especially important to clean up spills and remove contaminants, such as abrasives, from the sample changer's moving parts. It may also be necessary to chemically neutralize spills. The following sections explain daily and weekly cleaning procedures.



WARNING

Shock Hazard from Liquids

Liquid coming in contact with electrical components may result in a serious injury through shock.

- ▶ Do not allow any liquid to enter the device cabinet other than as intended through the specified tubing, or come into contact with any electrical components.
- ▶ The device must be thoroughly dry before you reconnect power, or turn the device on.

9.1.1 Daily External Cleaning

Use of the sample changer often results in spills on sample changer components. Good maintenance requires that you clean the sample changer daily. To do so, complete the following steps:

- Shut down and unplug the sample changer.
For information about shutting down the sample changer, see [Shutting Down the Sample Changer](#) [▶ 36].
- Wipe the sample changer cabinet and sample changer arm using a towel dampened with a lab-grade cleaning agent.



CAUTION

Cleaning Agent Hazard

Do not allow the cleaning agent to come into contact with the lead screws. Also, never lubricate either of the two lead screws.

- Repeat step two, using a towel dampened with clear water.
This process removes any remaining contaminants.
- Dry all components using a dry towel.
The sample changer must be thoroughly dry before you turn the power on.

9.1.2 Weekly Cleaning

Although cleaning it daily removes spills and contaminants from most of the sample changer components, it is necessary to clean the sample changer more thoroughly once a week. To do so, complete the following steps:

- Shut down and unplug the sample changer.
- Wipe loose particles off the Y-Axis lead screw with a dry, lint-free cloth.
The Y-Axis lead screw is a large metal screw located inside the sample changer arm tubing.



CAUTION

Hazard from Improper Lubrication

Never lubricate the lead screws. The lead screw nuts are compounded with a dry film lubricant. Oiling the lead screws will cause gumming, galling, and binding of the gripper assembly.

- Wipe the sample changer exterior and base until they are clean, using a towel dampened with a lab-grade cleaning agent, followed by a towel dampened with clear water.
Pay special attention to the slider block and guide rails along the tube of the sample changer arm.

9.2 Mounting the Z-Drive Assembly

Follow these instructions if you need to mount the Z-drive after cleaning or maintenance. Reverse the steps if you need to remove the Z-drive.

9.2.1 Tools Required

You will need the following tools:

- Phillips-head screwdriver.

⚠ CAUTION**Device Damage Hazard from Plugging in Z-Drive during Operation**

Plug in the Z-drive cable before powering on the device. Do not unplug the Z-drive cable with the device powered on. Plugging or unplugging the Z-drive cable with the power on may cause serious damage to the device.

- Turn off the sample changer.
- Slide the carriage to the end of the Y-arm.



Figure 9.1: Positioning the Carriage.

- Slide the Z-drive onto the y-arm.

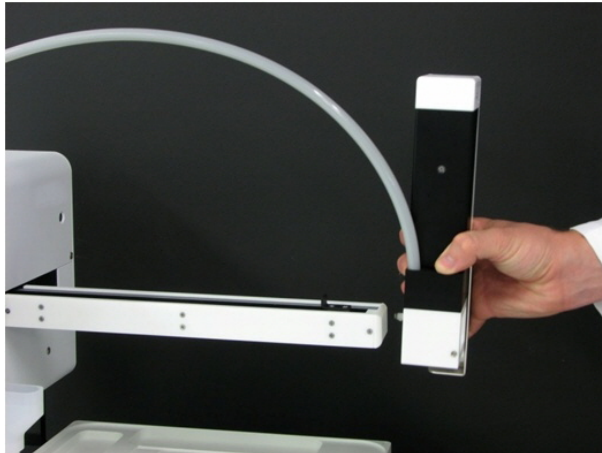

Figure 9.2: Sliding the Z-Drive onto the Y-Arm.

- Secure the screw.



Figure 9.3: Attaching the Z-Drive to the Carriage.

- Screw the strain-relief block to the sample changer.



Figure 9.4: Attaching the Z-Drive Strain Relief Block

- Plug the cable into the 15-pin connection port on the rear of the sample changer, and tighten the screws.

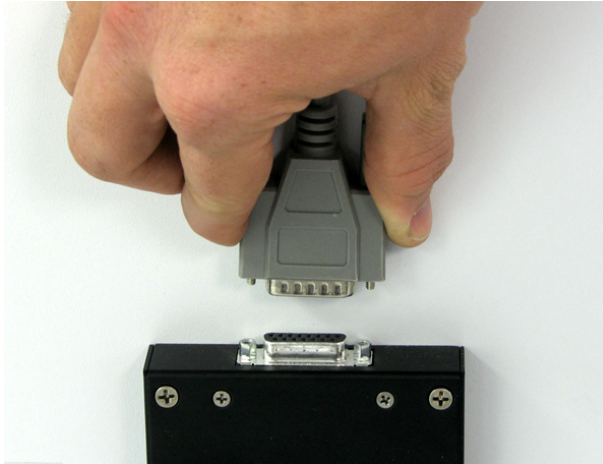

Figure 9.5: Connecting the Z-Drive Cable

9.2.2 Using Tubing Tamers

- Attach the Tubing Tamer to the Z-Drive. Run any communications wires and sample tubing along the Z-Drive cable through the tamers.



Figure 9.6: Connecting Tubing Tamer



Figure 9.7: Tubing Tamer Properly Installed on Z-Drive Cable

9.2.3 Connecting the Pneumatic Tubing

- Connect the tubing to the appropriate fittings on the back of the sample changer.



Figure 9.8: Gripper Tubing Connection on Back of Sample Changer

- Connect the tubing to the appropriate fittings on the gripper.

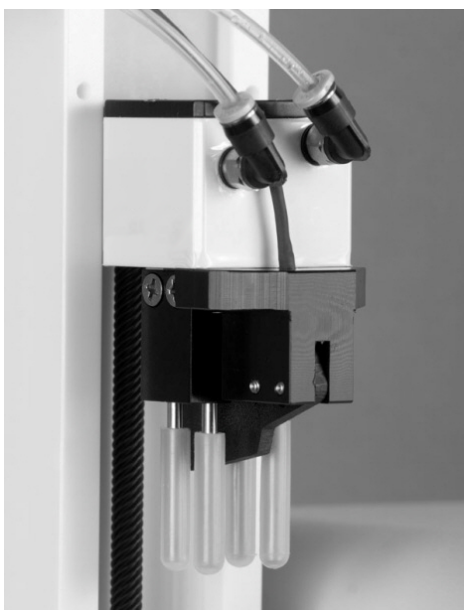

Figure 9.9: Gripper Tubing Connected to the Gripper on the Z-Drive

9.2.4 Connecting the Auxiliary Connector

- Connect the wires from the gripper to the auxiliary connector as shown.

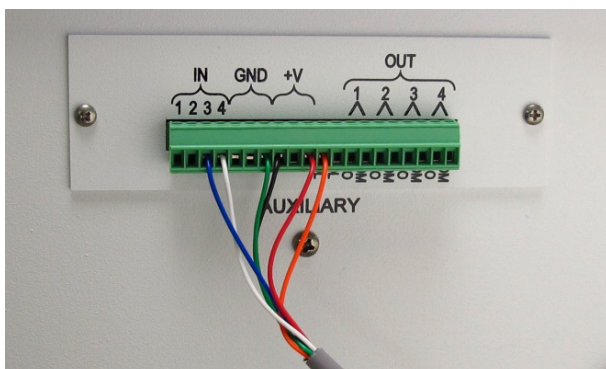

Figure 9.10: Auxiliary Connector

- Route the tubes and wires through the tubing tamers. Make sure that the tubes and wires are positioned so that they will not catch on anything when the sample changer moves.



Figure 9.11: Tubing After Installation

10 Troubleshooting

In the event that the product does not function properly, isolate the problem to determine if it originates in the host computer, the NMR instrument, or the sample changer.

This chapter explains how to troubleshoot sample changer problems. If you cannot solve a problem using the steps given in this chapter, you should contact BRUKER.

10.1 Power System Problems

A possible cause of system malfunction is a problem in the power system. If the system is not functional, it is possible that it is not receiving power. If this is the case, both of the LED status indicator lights will be off. To troubleshoot this problem, complete the following steps in sequence until the problem is solved:

- Check that the power switch on the sample changer is turned on.
- Check that the power cord is plugged in firmly between the power input on the sample changer and the external power supply and also between the power supply and the wall outlet.

If the cable is plugged in, ensure that it is not damaged in any way.

- Check that the LED on the power supply is illuminated.

If the LED is not illuminated, check the wall outlet using a device approved for that purpose.

If the wall outlet is working and the voltage is acceptable, unplug the external power supply from the sample changer, but leave it plugged into the wall.

- If the LED is not lit, the power supply is faulty and requires replacement.
- If the LED is lit when unplugged from the sample changer but turns off when plugged into the sample changer, the sample changer may have an internal short and requires repair.
- If the external power supply LED is illuminated while plugged into the sample changer, cycle the sample changer power switch. The gripper should move up and the sample changer should initialize. After initialization, the status LED on the front of the sample changer should light up.
 - If the cords are properly connected, power is available, the external power supply is good, and the device still does not initiate, continue troubleshooting.

10.2 Communications Interface Problems

Operation of the sample changer is directed by the host computer. A malfunction can indicate a problem with the USB cable or with the configuration of the software on the host computer. The following sections explain how to troubleshoot these problems.

10.2.1 USB Cable Problems

- Check that the USB cable is plugged into the port on the sample changer.
- Check the host computer to ensure that the USB cable is connected to the appropriate USB port.
- Check that the USB cable is not damaged in any way.
- Check the host computer to ensure that the USB drivers are installed for USB operation of the sample changer.

Load the proper USB drivers to the host computer from the installation media that was provided with the sample changer.

10.3 Returning the Product for Service

Refer to the following information if you need to return the product for service.

10.3.1 Shipping the Product

Follow these guidelines when shipping the product:

- **Use the original packing materials.** If the original shipping materials are not available, place a generous amount of shock-absorbing material around the instrument and place it in a box that does not allow movement during shipping. Seal the box securely.
- Contact BRUKER before shipping the product.
- Pre-pay all shipping expenses including adequate insurance.
- Write the following information on a tag and attach it to the product:
 - Name and address of the owner.
 - Product model number and serial number.
 - Description of service required or failure indications.
- Mark the shipping container as FRAGILE.
- In all correspondence, refer to the instrument by model name or number and full serial number.
- **Do not return products which are contaminated by radioactive materials, infectious agents, or other materials constituting health hazards to service employees.**



Note: Contact BRUKER or refer to the warranty information which came with your product for the exact terms of your warranty.

11 Dismantling and Disposal

Following the end of its operational life, the device must be dismantled and disposed of in accordance with the environmental regulations.



Installation, initial commissioning, retrofitting, repairs, adjustments or dismantling of the device must only be carried out by Bruker Service or personnel authorized by Bruker. Damage due to servicing that is not authorized by Bruker is not covered by your warranty.

11.1 Safety

WARNING



Danger of injury from electrical shock!

A life threatening shock may result when the housing is open during operation.

- ▶ Only qualified personnel should open the housing.
- ▶ Disconnect the device from the electrical power supply before opening the device. Use a voltmeter to verify that the device is not under power!
- ▶ Be sure that the power supply cannot be reconnected without notice.

WARNING



Danger of injury due to improper dismantling!

Stored residual energy, angular components, points and edges on and in the device or on the tools needed can cause injuries.

- ▶ Ensure sufficient space before starting work.
- ▶ Handle exposed, sharp-edged components with care.
- ▶ Dismantle the components properly.
- ▶ Secure components so that they cannot fall down or topple over.
- ▶ Consult the manufacturer if in doubt.

11.2 Dismantling

Before starting dismantling:

1. Shut down the device and secure to prevent restarting.
2. Disconnect the power supply from the device; discharge stored residual energy.
3. Remove consumables, auxiliary materials and other processing materials and dispose of in accordance with the environmental regulations.
4. Clean assemblies and parts properly and dismantle in compliance with applicable local occupational safety and environmental protection regulations.

11.3 Disposal

After the lifespan of the product, Bruker takes responsibility for disassembly and disposal in accordance with the European Directive WEEE 2012/19/EC. Bruker BioSpin will take back the components free of charge upon request by the customer. If the customer wants to arrange disposal on their own, then this must be stated when the product is ordered.

European Waste Electrical and Electronic Equipment Directive (WEEE 2012/19/EC)

Do not dispose in domestic household waste.



The affixed label indicates that it is prohibited to discard this electrical/electronic product in domestic household waste, in compliance with the European Waste Electrical and Electronic Equipment Directive (WEEE 2012/19/EC).

For instructions on how to return end-of-life equipment, producer-supplied electrical accessories or auxiliary items for proper disposal contact the supplier or importer. If the supplier cannot be reached, contact the manufacturer.

NOTICE

Danger to the environment from incorrect handling of pollutants!

Incorrect handling of pollutants, particularly incorrect waste disposal, may cause serious damage to the environment.

- ▶ Always observe local environmental regulations regarding handling and disposal of pollutants.
- ▶ Take the appropriate actions immediately if pollutants escape accidentally into the environment. If in doubt, inform the responsible municipal authorities about the damage and ask about the appropriate actions to be taken.

12 Contact

Manufacturer:

Bruker BioSpin GmbH
Am Silberstreifen
D-76287 Rheinstetten
Germany
Helpdesk Europe: (+49) 721-5161-6155
Helpdesk USA: (+1) 978-667-9580
E-Mail: minispec.SLS@bruker.com
<http://www.bruker.com>
WEEE DE43181702

Bruker BioSpin Hotlines

Contact our Bruker BioSpin service centers.

Bruker BioSpin provides dedicated hotlines and service centers, so that our specialists can respond as quickly as possible to all your service requests, applications questions, software or technical needs.

Please select the service center or hotline you wish to contact from our list available at:

<http://www.bruker.com/service/information-communication/helpdesk/magnetic-resonance.html>

13 Glossary

NMR Instrument: The instrument to which the sample changer is connected.

Host Computer: The computer that controls operation of the instrument to which the sample changer is attached, and through which the sample changer is controlled.

Hz: Hertz.

PTFE: Polytetrafluoroethylene.

VAC: Volts Alternating Current.

VDC: Volts Direct Current.

X-Axis: The left-to-right axis of the sample changer.

Y-Axis: The front-to-back axis of the sample changer.

Z-Axis: The up-and-down axis of the sample changer.

Z-Drive Assembly: The motorized assembly which rides on the arm of the sample changer and moves the gripper up and down.

List of Figures

Figure 3.1:	Overview of the Mechanical Hazards (Without Optional Safety Barrier)	11
Figure 3.2:	Overview of the Mechanical Hazards (With Optional Safety Barrier)	11
Figure 5.1:	Sample Automation XYZ Sample Changer—Front View with TC3 (10 mm SFC Version), TC6 and MFC Analyzer	17
Figure 5.2:	Sample Automation XYZ Sample Changer—Front View with TC3 (2 Zone 26 mm Version) and Sample Stage	18
Figure 5.3:	Sample Automation XYZ Sample Changer—Back View of Sample Changer Head. ...	19
Figure 5.4:	TC3 and TC6 Temperature Units.	20
Figure 7.1:	Mounting Bracket.....	27
Figure 7.2:	E-Stop Shown on Left Side of the Base	28
Figure 7.3:	Location of Holes in the Bracket	28
Figure 7.4:	Location of Mounting Screws.....	28
Figure 7.5:	Rear View of E-Stop After Mounting (Shown mounted to safety barrier so that screw locations are more visible)	29
Figure 7.6:	E-stop Connected to the Sample Changer	29
Figure 7.7:	Message showing that a driver was not found.....	31
Figure 7.8:	Choosing to install USB driver	31
Figure 7.9:	Choosing to install USB driver from a removable media	31
Figure 7.10:	Searching for the driver	32
Figure 7.11:	Selecting the driver	32
Figure 7.12:	Driver installation is complete	33
Figure 9.1:	Positioning the Carriage.	39
Figure 9.2:	Sliding the Z-Drive onto the Y-Arm.	39
Figure 9.3:	Attaching the Z-Drive to the Carriage.	40
Figure 9.4:	Attaching the Z-Drive Strain Relief Block.....	40
Figure 9.5:	Connecting the Z-Drive Cable	41
Figure 9.6:	Connecting Tubing Tamer	41
Figure 9.7:	Tubing Tamer Properly Installed on Z-Drive Cable	41
Figure 9.8:	Gripper Tubing Connection on Back of Sample Changer.....	42
Figure 9.9:	Gripper Tubing Connected to the Gripper on the Z-Drive.....	42
Figure 9.10:	Auxiliary Connector.....	42
Figure 9.11:	Tubing After Installation.....	43

List of Tables

Table 3.1: Explanation of Caution and Warning Notices	12
Table 4.1: Environmental Characteristics	15
Table 4.2: Power Requirements	15
Table 4.3: Data Connectors on the Sample Changer	16
Table 4.4: Data Connectors - Temperature Units	16
Table 7.1: Physical Characteristics	26

Index

A

avis Canadien 13

B

Balance adapter kit 21

C

cleaning 37
condensationSee humidity 23

D

dimensions 26
Disassembly 48
disposal 48

E

earthing 26
electrical characteristics 15
E-stop 19, 36
E-stop button 27

F

FCC notice 13

G

grounding 26

H

humidity 10, 15, 23

I

ICES 001 13
intended use 7
interference 13, 33

L

lamps
power 17, 36
power supply 45
LEDs
lampsSee 17
lifting instructions 23, 25

M

mains disconnect 9

O

operator qualifications 7

P

pollution degree 15
power
connections 29
power-on procedure 36
requirements 15, 26
power cord 9

Q

qualifications, operator 7

R

regulatory notices 9
return procedure 46

S

safety barrier 21
safety information 9
Sample stage 20, 21
service 46

T

Temperature
Operating 15
tubing
kinks 23

V

vibration 26

W

warranty 46
WEEE notice 48
work surface requirements 26





Bruker Corporation

info@bruker.com
www.bruker.com

Order No: H148850