

SmartCooler BCU I

- User Manual

Version 003



Copyright © by Bruker Corporation

All rights reserved. No part of this publication may be reproduced, stored in a retrieval system, or transmitted, in any form, or by any means without the prior consent of the publisher. Product names used are trademarks or registered trademarks of their respective holders.

© April 06, 2018 Bruker Corporation

Document Number: Z4D12628B

P/N: Z33119

Contents

1	About	5
1.1	Policy Statement	5
1.2	Symbols and Conventions	5
2	Safety	7
2.1	Intended Use	7
2.2	System Owner's Responsibility	7
2.3	Personnel Requirements	8
2.4	Basic Dangers	8
2.4.1	General Workplace Dangers	9
2.4.2	Dangers from Electric Power	9
2.4.3	Dangers from Magnetic Fields	10
2.5	Signage	11
2.6	Spare Parts / Accessories	11
3	Introduction	13
3.1	SmartCooler BCU I	13
3.2	Technical Data	14
3.2.1	General Information	15
3.3	Installation and Initial Commissioning	17
3.4	Limitation of Liability	17
3.5	Copyright	17
3.6	Warranty Terms	17
3.7	Customer Service	17
4	Transport, Packaging and Storage	19
4.1	Symbols on the Packaging	19
4.2	Inspection at Delivery	20
4.3	Packaging	20
4.4	Storage	21
4.5	Unpacking	21
4.6	Unpacking Procedure	22
5	Preparation	25
6	Installation	29
7	Operation	31
7.1	Operation Modes	31
7.2	Status and Remote LED	32
7.3	Manual Operation Modes BCU I	33
7.4	Remote Operation Modes on BSVT	33
7.5	Remote Operation Modes on BVT	34
8	Maintenance	35
8.1	Safety	35
8.2	Required Parts	37

Contents

8.3	Maintenance Work	38
9	Troubleshooting	39
9.1	Problems & Solutions.....	40
10	Replacement of Parts	43
10.1	Returning the Unit for Repair	43
11	Dismantling and Disposal.....	45
11.1	Dismantling	45
11.2	Disposal Europe.....	45
11.3	Disposal USA and Other Countries	46
12	Contact	47

1 About

1.1 Policy Statement

It is Bruker's policy to improve products as new techniques and components become available. Bruker reserves the right to change specifications at any time.

Every effort has been made to avoid errors in text and Figure presentation in this publication. In order to produce useful and appropriate documentation, we welcome your comments on this publication. Field Service Engineers are advised to check regularly with Bruker for updated information.

Bruker is committed to providing customers with inventive, high-quality, environmentally-sound products and services.

1.2 Symbols and Conventions

Safety instructions in this manual and labels of devices are marked with symbols. .

The safety instructions are introduced using indicative words which express the extent of the hazard.

In order to avoid accidents, personal injury or damage to property, always observe safety instructions and proceed with care.

DANGER



DANGER indicates a hazardous situation which, if not avoided, will result in death or serious injury.

This is the consequence of not following the warning.

1. This is the safety condition.
 - ▶ This is the safety instruction.

WARNING



WARNING indicates a hazardous situation, which, if not avoided, could result in death or serious injury.

This is the consequence of not following the warning.

1. This is the safety condition.
 - ▶ This is the safety instruction.

CAUTION



CAUTION indicates a hazardous situation, which, if not avoided, may result in minor or moderate injury or severe material or property damage.

This is the consequence of not following the warning.

1. This is the safety condition.
 - ▶ This is the safety instruction.

NOTICE

NOTICE indicates a property damage message.

This is the consequence of not following the notice.

1. This is a safety condition.
 - ▶ This is a safety instruction.

SAFETY INSTRUCTIONS

SAFETY INSTRUCTIONS are used for control flow and shutdowns in the event of an error or emergency.

This is the consequence of not following the safety instructions.

1. This is a safety condition.
 - ▶ This is a safety instruction.



This symbol highlights useful tips and recommendations as well as information designed to ensure efficient and smooth operation.

2 Safety

2.1 Intended Use

The device has been designed and constructed solely for the intended use described here.

The SmartCooler™ BCU I is the successor model of the BCU05. The lowest temperature of the cooled VT gas is with a BCU I below -40°C up to 50 NI/min. The SmartCooler™ BCU I produces the cooling energy via one compressor refrigerator with electrical power. This SmartCooler™ is recommended for NMR experiments with a sample temperature T_S between 0°C and T_{RT} .

Intended use also includes compliance with all specifications within this manual. Any use which exceeds or differs from the intended use shall be considered improper use. No claims of any kind for damage will be entertained if such claims result from improper use.

2.2 System Owner's Responsibility

System Owner

The term *system owner* refers to the person who operates the device for trade or commercial purposes, or who surrenders the device to a third party for use/application, and who bears the legal product liability for protecting the user, the personnel or third parties during the operation.

System Owner's Obligations

The device is used in the industrial sector, universities and research laboratories. The system owner of the device must therefore comply with statutory occupational safety requirements.

In addition to the safety instructions in this manual, the safety, accident prevention and environmental protection regulations governing the operating area of the device must be observed.

In this regard, the following requirements should be particularly observed:

- The system owner must obtain information about the applicable occupational safety regulations, and - in the context of a risk assessment - must determine any additional dangers resulting from the specific working conditions at the usage location of the device. The system owner must then implement this information in a set of operating instructions governing operation of the device.
- During the complete operating time of the device, the system owner must assess whether the operating instructions issued comply with the current status of regulations, and must update the operating instructions if necessary.
- The system owner must clearly lay down and specify responsibilities with respect to installation, operation, troubleshooting, maintenance and cleaning.
- The system owner must ensure that all personnel dealing with the device have read and understood this manual. In addition, the system owner must provide personnel with training and hazards information at regular intervals.
- The system owner must provide the personnel with the necessary protective equipment.

- The system owner must warrant that the device is operated by trained and authorized personnel as well as all other work, such as transportation, mounting, start-up, the installation, maintenance, cleaning, service, repair and shutdown, that is carried out on the device.
- All personnel who work with, or in the close proximity of the device, need to be informed of all safety issues and emergency procedures as outlined in this user manual.
- The system owner must document the information about all safety issues and emergency procedures in a laboratory SOP (Standard Operating Procedure). Routine briefings and briefings for new personnel must take place.
- The system owner must ensure that new personnel are supervised by experienced personnel. It is highly recommended to implement a company training program for new personnel on all aspects of product safety and operation.
- The system owner must ensure that personnel are regularly informed of the potential hazards within the laboratory. This is all personnel that work in the area, but in particular laboratory personnel and external personnel such as cleaning and service personnel.
- The system owner is responsible for taking measures to avoid inherent risks in the handling of dangerous substances, preventing industrial disease, and providing medical first aid in emergencies.
- The system owner is responsible for providing facilities according to the local regulations for the prevention of industrial accidents and generally accepted safety regulations according to the rules of occupational medicine.
- All substances needed for operating and cleaning the device samples, solvents, cleaning agents, gases, etc. have to be handled with care and disposed of appropriately. All hints and warnings on storage containers must be read and adhered to.
- The system owner must ensure that the work area is sufficiently illuminated to avoid reading errors and faulty operation.
- The system owner must ensure that the laboratory is equipped with an oxygen warning device, in case the device is operated with nitrogen.

Furthermore, the system owner is responsible for ensuring that the device is always in a technically faultless condition. Therefore, the following applies:

- The system owner must ensure that the maintenance intervals described in this manual are observed.
- The system owner must ensure that all (electrical, mechanical, etc.) safety devices are regularly checked to ensure full safety functionality and completeness.

2.3 Personnel Requirements



Only trained Bruker personnel are allowed to install, mount, retrofit, repair, adjust and dismantle the unit!

2.4 Basic Dangers

The following section specifies residual risks which may result from using the device and have been established by means of a risk assessment.

In order to minimize health hazards and avoid dangerous situations, follow the safety instructions specified here as well as in the following chapters of this manual.

2.4.1 General Workplace Dangers

WARNING

Danger to life from nonfunctional or insufficient safety devices!

If safety devices are not functioning or are disabled, there is a danger of serious injury or death.

- ▶ Check that all safety devices are fully functional and correctly installed before starting work.
- ▶ Never disable or bypass safety devices.
- ▶ Ensure that all safety devices are always accessible.

2.4.2 Dangers from Electric Power

WARNING

Danger of injury from electrical shock!

A life threatening shock may result when the housing is open during operation.

- ▶ Only qualified personnel should open the housing.
- ▶ Disconnect the device from the electrical power supply before opening the device. Use a voltmeter to verify that the device is not under power!
- ▶ Be sure that the power supply cannot be reconnected without notice.

WARNING

Danger to life from residual electrostatic potentials!

Friction between material being conveyed may result in significant development of electrostatic potential. Therefore, contact with parts immediately following the conveying operation may be life-threatening.

- ▶ Potential equalisation must be ensured before making contact with parts, unless such equalisation is provided by the customer.

WARNING

Electrical hazard from electrical shock

Absent or faulty protective earth conductor may result in contact voltage. This may pose a risk of injury or death.

- ▶ Before the initial commissioning of the device, connect the main power supply to the socket and verify the complete functionality of the protective earth conductor.



2.4.3 Dangers from Magnetic Fields

WARNING

Risk to life due to high magnetic fields

A magnetic field of more than 0.5 mT (5 Gauss) is life-threatening for people with pacemakers or active metal implants. Exposure to more than 8 T can cause damage to health. Duration of exposure (8 h/day) above the limit of 200 mT can cause damage to health. Ferromagnetic tools in the magnetic field are significantly hazardous. Disks and electronic devices may be damaged.



- ▶ Mark the magnetic field of more than 0.5 mT (5 Gauss) before start up.
- ▶ Keep people with active medical implants or heart pacemakers away from the 0.5 mT (5 Gauss) area.
- ▶ The permanent workplace of employees must be outside the 0.5 mT (5 Gauss) area.
- ▶ Do not stay or work at magnetic fields of more than 8 T.
- ▶ Prevent exposure of more than 200 mT for more than 8 h/day.
- ▶ Keep disks, credit cards and electronic devices away from the identified area.
- ▶ Do not use ferromagnetic tools or items within the identified area.
- ▶ Only use non-ferromagnetic transportation dewars or pressure cylinders for the cryogenic agents.
- ▶ Only use non-ferromagnetic ladders or steps.
- ▶ Remove magnetic items (jewelry, watches, pens etc.) before carrying out maintenance work.

WARNING

Risk to life due to strong magnetic fields

The SmartCooler™ BCU I is magnetic and presents a potential hazard in the vicinity of a magnet (e.g. magnetic fringe field of the NMR magnet).



- ▶ For Ascent™ (all frequencies) and other magnets ≤ 700 MHz, place the BCU I outside the 0.5 mT (5 G) and not less than 1 m from the axis of the magnet.
- ▶ For magnets ≥ 700 MHz, place the BCU I outside the 5 mT (50 G) line and not less than 2.7 m from the axis of the magnet.

2.5 Signage

The following symbols and information signs can be found in the work area. They refer to their immediate surroundings.



The identification and placement of warning labels are included in the manual. The laboratory supervisor is responsible for ensuring that all the warning labels are maintained in their proper place any time that the device is used.

Danger Spot



Warning indicating a danger spot in work rooms.
The warning label may be ordered using Bruker Part Number 67470.

2.6 Spare Parts / Accessories

Loss of Guarantee

The use of non-approved spare parts will invalidate the manufacturer's guarantee.
Purchase spare parts and accessories from authorized dealers or directly from the manufacturer. See Contact for manufacturer's address.

3 Introduction

3.1 SmartCooler BCU I

The SmartCooler™ BCU I is the successor model of the BCU05. The lowest temperature of the cooled VT gas is with a BCU I is below -40 °C up to 50 NI/min. The SmartCooler™ BCU I and also the BCU05 produce the cooling energy via one compressor refrigerator with electrical power. This SmartCooler™ is recommended for NMR experiments with a sample temperature T_S between 0 °C and T_{RT} . For easier reading, this cooling system is often referred to as BCU I in this manual.



Figure 3.1: SmartCooler BCU I

The BCU I is available with a transfer line length of 2 m, 3 m, 5 m or 8 m. The magnet type defines which BCU I has to be ordered. Below is a list of the relative BCU I transfer line lengths associated with the most common magnets (other magnets on request).

- 2 m: 400 US PLUS/R SB (Nitrogen free Z107439); all Ascend™ (all frequencies!); all USplus SB LH; all USplus SB ULH; all US SB ULH; 300 – 500 US SB LH; 300 & 400 US WB LH; USplus WB LH; 92137 (500/54/AS Magnex); 91843 (500/52 Magnex); 40797 (500/51 AS Oxford); 47410 (AS500/54)
- 3 m: 600 & 700 US SB LH; 500 US WB LH, 800 & 850 US2 Plus SB (Compact)
- 5 m: 600 US WB LH; 800 US SB; 900 US SB; Z29704 (600/52 LL); 800 – 950 US2 SB; Z29715 (500/52LL); M10910 (900 MHz/54 US2); 29563 (750/52 Magnex); O019 (500/52LL), O048 (400/54 Oxford)
- 8 m: 1000 US SB

For BRUKER magnets the following rules are valid to determine the minimal transfer line length of a BCU I:

- Ascend™ (all frequencies) and all other magnets \leq 700 MHz: Place the BCU I outside the 0.5 T (5 G) line and not less than 1m from the axis of the magnet.
- Magnets \geq 750 MHz: Place the BCU I outside the 5 mT (50 G) line and not less than 2.7 m from the axis of the magnet.

Below is shown a possible 400 MHz magnet system with room temperature (RT) probe and a VT gas cooling option with SmartCooler™ BCU I.

HR – RT Probe for Liquids: 400 MHz
(for air compensated probes)

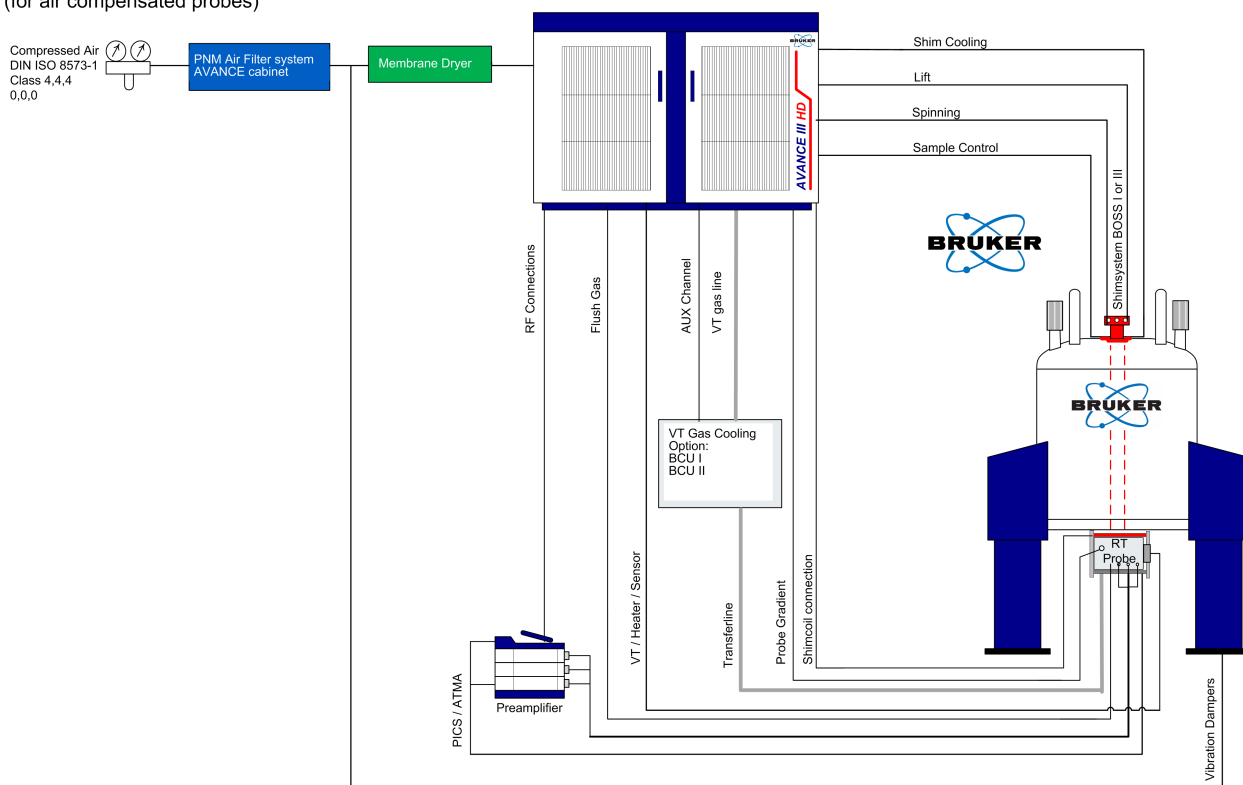

Figure 3.2: Schema with BCU

3.2 Technical Data

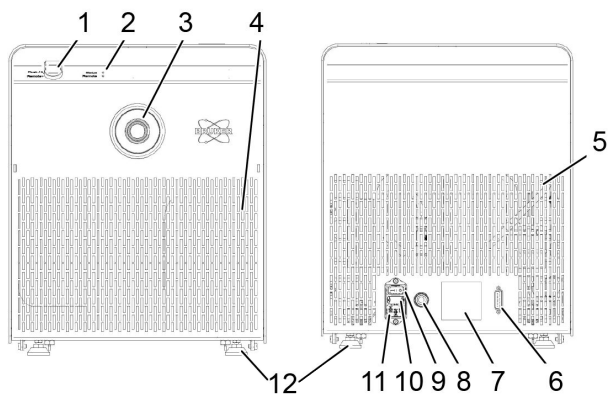

Figure 3.3: View of the BCU of the front and the back.

1	Rotary switch	7	Rating plate
2	LEDs (2x)	8	Variable temperature (VT) gas IN Ø=8mm (max. 6bar)
3	Transfer line – VT gas OUT	9	Main switch
4	Air inlet grid	10	Fuse (2 x 5 x 20mm 10AT)
5	Air outlet grid	11	Power socket
6	D-Sub 15 socket	12	Hexagon sockets (4x)

3.2.1 General Information

Data	Value
Weight	~ 30 kg
Length	48 cm
Width	35.1 cm
Height	42.5 cm
Transfer line length	2, 3, 5 or 8 m
Sound pressure level	< 60 dB(A)

Electrical Information

Type 1	220 V – 240 V ~ 50 Hz	Max. 2.1 A
Type 2	115 V ~ 60 Hz	Max. 4.7 A
Type 3	200 V – 220 V ~ 50 Hz 200 V – 220 V ~ 60 Hz	Max. 2.2 A Max. 2.4 A
Power Requirement	600 VA	
Power Consumption	280 W	
Cool down time	~15 min	
Circuit protection	2 Fuses 5 x 20 mm 10 AT	

Gas Supply

Data	Value
Min. gas temperature (end of transfer line)	-40 °C @ 0 – 3000 l/h & 17...25 °C ambient temperature
Gas dew point temperature	≤ -50 °C @ 1 bar
Flow rate	0...3000 NI/h

Operating Environment

Data	Value
Ambient operating temperature range	Min 17 °C, max 32 °C, 17...25 °C, specifications fulfilled

For the appropriate temperature see also the Bruker site planning guides on the BASH CD (Bruker Advanced Service Handbook).

Rating Plate

The rating plate is located at the power input and includes the following information:

- Manufacturer
- Type
- Voltage
- Frequency
- Apparent power consumption, maximum
- Year of Production
- PN: Part Number
- SN: Serial Number
- V: Variant
- ECL: Engineering Change Level
- Refrigerant

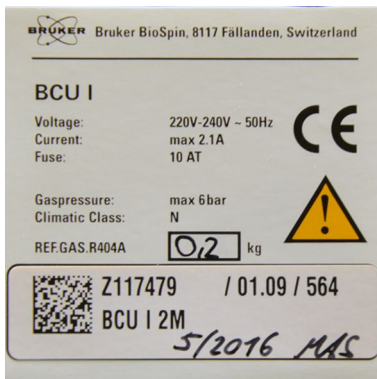

Figure 3.4: BCU I Type 1: 220 V – 240 V ~ 50 Hz, max. 2.1 A

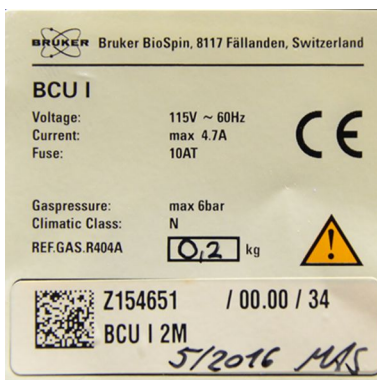

Figure 3.5: BCU I Type 2: 115 V ~ 60 Hz, max. 4.7 A

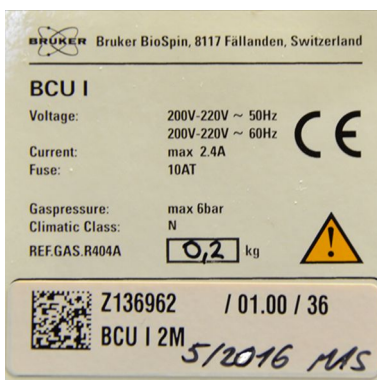

Figure 3.6: BCU I Type 3: 200 V – 220 V ~ 50 Hz/ ~ 60 Hz, max. 2.4 A

3.3 Installation and Initial Commissioning



Installation, initial commissioning, retrofitting, repairs, adjustments or dismantling of the device must only be carried out by Bruker Service or personnel authorized by Bruker. Damage due to servicing that is not authorized by Bruker is not covered by your warranty.

3.4 Limitation of Liability

All specifications and instructions in this manual have been compiled taking account of applicable standards and regulations, the current state of technology and the experience and insights we have gained over the years.

The manufacturer accepts no liability for damage due to:

- Failure to observe this manual.
- Improper use.
- Deployment of untrained personnel.
- Unauthorized modifications.
- Technical modifications.
- Use of inadmissible spare parts.

The actual scope of supply may differ from the explanations and depictions in this manual in the case of special designs, take-up of additional ordering options, or as a result of the latest technical modifications.

The undertakings agreed in the supply contract, as well as the manufacturer's Terms and Conditions and Terms of Delivery, and the legal regulations applicable at the time of the conclusion of the contract shall apply.

3.5 Copyright

All rights reserved. This manual is protected by copyright and intended solely for internal use by customers.

This manual must not be made available to third parties, duplicated in any manner or form – whether in whole or in part – and the content must not be used and/or communicated, except for internal purposes, without the written consent of the manufacturer.

Product names used are trademarks™ or registered trademarks® of their respective holders.

Violation of the copyright will result in legal action for damages. We reserve the right to assert further claims.

3.6 Warranty Terms

The warranty terms are included in the manufacturer's Terms and Conditions.

3.7 Customer Service

Our customer service division is available to provide technical information. See the chapter Contact for contact information.

In addition, our employees are always interested in acquiring new information and experience gained from practical application; such information and experience may help improve our products.

4 Transport, Packaging and Storage



Installation, initial commissioning, retrofitting, repairs, adjustments or dismantling of the device must only be carried out by Bruker Service or personnel authorized by Bruker. Damage due to servicing that is not authorized by Bruker is not covered by your warranty.

4.1 Symbols on the Packaging

The following symbols are affixed to the packaging material. Always observe the symbols during transport and handling.



Top		The arrow tips on the sign mark the top of the package. They must always point upwards; otherwise the content may be damaged.
Fragile		Marks packages with fragile or sensitive contents. Handle the package with care; do not allow the package to fall and do not allow it to be impacted.
Protect Against Moisture		Protect packages against moisture and keep dry.

Table 4.1: Symbols on the Packaging

4.2 Inspection at Delivery

Upon receipt, immediately inspect the delivery for completeness and transport damage.



Figure 4.1: Shock sensor

Therefore check the Tilt watches on both sides of the packaging.

Proceed as follows in the event of externally apparent transport damage:

- Do not refuse delivery/receipt.
- Make notation on delivery receipt and inspect for damage.
- If damage is discovered, leave in original container and packaging and request immediate inspection from carrier with 3 days of delivery.



Issue a complaint in respect to each defect immediately following detection. Damage compensation claims can only be asserted within the applicable complaint deadlines.

4.3 Packaging

About Packaging

The individual packages are packaged in accordance with anticipated transport conditions. Only environmentally friendly materials have been used in the packaging.

The packaging is intended to protect the individual components from transport damage, corrosion and other damage prior to assembly. Therefore do not destroy the packaging and only remove it shortly before assembly.

Handling Packaging Materials

Keep the original container and packing assembly, at least as long the warranty is valid, in case the unit has to be returned to the factory. When the packaging material is no longer needed dispose of it in accordance with the relevant applicable legal requirements and local regulations.

4.4 Storage

Storage of the Packages

Store the packages under the following conditions:

- Do not store outdoors.
- Store in dry and dust-free conditions.
- Do not expose to aggressive media.
- Protect against direct sunlight.
- Avoid mechanical shocks.
- Storage temperature: 15 to 35 °C.
- Relative humidity: max. 60%.
- If stored for longer than 3 months, regularly check the general condition of all parts and the packaging. If necessary, top-up or replace preservatives.



Under certain circumstances, storage instructions may be affixed to packages which expand the requirements specified here. Comply with these accordingly.

4.5 Unpacking

The following components are included in the package:

- 1 BCU I
- 1 Support clamp (Z53660)
- 1 BSCU support (Z119100) (only included for a BCU I with a transfer line length ≥ 3 m)
- 1 power cord
- 1 x O-ring 13 x 1,5 mm Viton FPM75 GR (for coupler at the end of the transfer line)
- 2 x Fuse 5 x 20 mm 10 AT

4.6 Unpacking Procedure



Check the Tilt watches when the box is positioned in the lab.



First open the black plastic belts.
Then cut the tapes along the cardboard box edges and on the top.



On top of the packed BCU I are the security hints and the packaging list provided. Keep them for later use.



Take the top layer of cardboard and plastic cover away.



Take the transfer line carefully out.



Lift together with a second person the BCU I (~30kg) out of the cardboard box.



Remove the butterfly nuts on the bottom of the BCU I and keep them for later use.



The BCU I can be placed according to the instructions in Preparation.



The protective foam cover for the transport has to be taken off the transfer line connector end.

Transport, Packaging and Storage



The white plastic cover has to be taken off, when the BCU I will be connected to the probe. When the transfer line is not connected cover the connector with the white plastic cover.



Check each time that the O-ring at the front of the transfer line connector is clean before it is connected to the probe.



Take the box with the supply material out.



The box contains:

- 1 Power cord
- 1 Support clamp (Z53660)

5 Preparation



CAUTION

Accident and material damage hazard due to flying objects

When the operator pressurizes the transfer line before the protective cover is taken off, it can shoot away.

- ▶ Remove the white protective cover of the transfer line before pressurizing the BCU with VT gas (max. 6 bar).

NOTICE

Instability and poor Vibration Damping of the Unit during Operation

Material damage may occur when the unit is not vibration damped.

- ▶ Release and remove the transport safety lock on the bottom of the housing.
- ▶ Store the packaging and the transport safety lock. Use only the original packaging for transportation or shipping.
- ▶ Do not place any object on top of the unit.

NOTICE

Material damage hazard from unit overheating.

Material damage may occur when the unit overheats as a result of a blocked air inlet and/or outlet.

- ▶ The unit must be mounted on a level and even surface.
- ▶ Around the unit there must be at least a 30 cm deep area clear of all obstructions.

NOTICE

Material damage hazard of the unit due to incorrect handling

Material damage may occur when the unit is repositioned by pulling on the transfer line.

- ▶ Do not pull on the transfer line in order to position the unit.

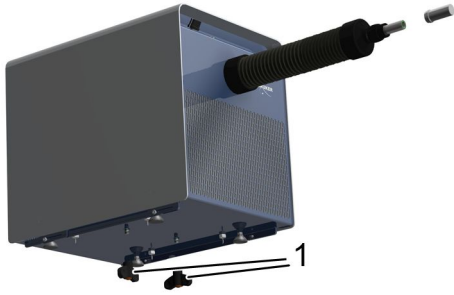

Release and remove the transport safety lock, which are the two butterfly nuts at the bottom of the BCU I housing (1).

Position the BCU I taking the magnetic fringe field into account.

- For Ascend™ (all frequencies) and all other magnets $\leq 700\text{MHz}$: Place the BCU I outside 0.5mT (5 G) and not less than 1m from the axis of the magnet.
- For magnets $\geq 750\text{MHz}$: Place the BCU I outside the 5mT (50 G) and not less than 2.7m from the axis of the magnet.



Unscrew and remove the white protective cover (1) at the end of the transfer line before pressurizing the BCU I with VT gas (max 6 bar).



Install the support clamp (Z53660) to the magnet flange.



Assemble and install the transfer line support BSCU support (Z119100) for systems with a transfer line $>2\text{m}$.

Optional equipment:



A MAS box (Z120576) is required with a BVT3x00 and MAS.



A membrane dryer (1808577) is required in case the VT gas does not meet the dew point temperature specifications (General Information).

See also

 [General Information \[▶ 15\]](#)

6 Installation

NOTICE

Material Damage due to Incorrect Gas Supply

Material damage may occur when the specifications for the gas supply have not been taken into account.

- ▶ Use VT gas with a pressure of max 6 bar.
- ▶ To prevent freezing and clogging of the BCU I use dry clean air or nitrogen VT gas at room temperature with a dew point temperature ≤ -50 °C @ 1bar according to the specifications.
- ▶ For the BCU I Bruker recommends the dryer 1808577 (≤ 60 nl/min).
- ▶ Install the gas dryer upstream the B(S)VT.
- ▶ For all tubing downstream the gas dryer use only hoses from TPS (low water permeability).

- Plug in the communication cable from the BSVT or from the SampleCase Cooled into the D-Sub 15 socket of the BCU I (Position 6).
- In case the BCU I is operated with a BVT, order the cable BSCU cable retrofit long (Z118350).



For NMR probes with a VT gas coupler as shown beside order the adapter Z121532.

For a CryoProbe order the adapter BSCU adapter CryoProbe Z119688.



Here the adapter Z121532 is shown



Here the BSCU adapter CryoProbe Z119688 is shown.

- Connect the transfer line to the VT gas coupler of the NMR probe.
- Align and level the transfer line using the support clamp (Z53660) and the transfer line support BSCU support (Z119100).
- Connect the VT gas line ($\varnothing=8$ mm) from the B(S)VT to the VT gas connection of the BCU I.
- The BCU I is ready for operation when the main power cable is plugged into the power socket of the BCU I and the mains power plug into the mains power socket outlet according to the voltage specifications on the label.

7 Operation

WARNING

Danger of injury from improper operation!

Improper operation can result in serious injury and significant damage to property.

- ▶ Carry out all operating steps in accordance with the specifications and instructions in this manual.
- ▶ Before starting work, ensure that
 - All covers and safety devices are installed and functioning properly.
 - No persons are in the danger zone.
- ▶ Never disable or bypass safety devices during operation.

7.1 Operation Modes

The BCU I has a rotary switch on the top left corner of the front to activate the different modes of the unit. Beside the rotary switch indicate two LEDs for **Status** and **Remote** the state of the unit.



Figure 7.1: Rotary switch of BCU I

7.2 Status and Remote LED

Status LED	Information
OFF	NO power
Green flashing	Cooling down / Warming up
Green ON	READY, stable temperature
Red flashing	WARNING, BCU I is overheating
Red ON	ERROR, see Troubleshooting for details

BCU I is connected with BSVT

Remote LED	Information
OFF	Manual Operation Mode or NO power
Green flashing	Connecting to BSVT
Green ON	Connected to BSVT
Red ON	ERROR, no connection

BCU I is connected with BVT

Remote LED	Information
OFF	Manual Operation Mode or NO power
Green flashing for 5 sec	Temperature control is ON, connecting to BVT
Green ON	Temperature control is ON, connected to BVT, BCU I ON
Red ON	NO connection or temperature control is OFF, BCU I OFF

7.3 Manual Operation Modes BCU I

Rotary switch	Operation	Notes
The BCU I is controlled by the BSVT (see Remote Operation Modes on BSVT [▶ 33]) or BVT (see Remote Operation Modes on BVT [▶ 34])		
Flush / 0 *	No cooling power	This setting is used when VT gas at room temperature has to be fed to the NMR probe or the VT gas tubing of the BCU I has to be dried and purged. In this setting the compressor is not running.
		Purge with dry clean air or nitrogen gas at room temperature with a dew point temperature $\leq -50^{\circ}\text{C}@1\text{bar}$
1 *	Medium cooling power	In this mode, the VT gas is cooled only slightly with reference to room temperature T_{RT} ($T = T_{\text{RT}} 0 \dots 20^{\circ}\text{C}$)
2 *	Maximum cooling power	In this maximum mode, the VT gas is cooled to the lowest specified temperature.

*) The BCU I is in a manual mode and cannot be controlled with the BVT or BSVT. In manual mode the BCU I can be operated without a communication cable to the B(S)VT.

7.4 Remote Operation Modes on BSVT

Rotary switch	TopSpin EDTE	Operation	Notes
Remote	Off	No cooling power	This setting is used when VT gas at room temperature has to be fed to the NMR probe or the VT gas tubing of the BCU I has to be dried and purged. In this setting the compressor is not running.
			Purge with dry clean air or nitrogen gas at room temperature with a dew point temperature $\leq -50^{\circ}\text{C}@1\text{bar}$
Remote	Medium	Medium cooling power	In this mode, the VT gas is cooled only slightly with reference to room temperature T_{RT} ($T = T_{\text{RT}} 0 \dots 20^{\circ}\text{C}$)
Remote	Maximum	Maximum cooling power	In this maximum mode, the VT gas is cooled to the lowest specified temperature.

7.5 Remote Operation Modes on BVT

Rotary switch	TopSpin EDTE	Operation	Notes
Remote	Off	No cooling power	This setting is used when VT gas at room temperature has to be fed to the NMR probe or the VT gas tubing of the BCU I has to be dried and purged. In this setting the compressor is not running.
			Purge with dry clean air or nitrogen gas at room temperature with a dew point temperature $\leq -50^{\circ}\text{C}@1\text{bar}$
Remote	On	Strong cooling power	In this maximum mode, the VT gas is cooled to the lowest specified temperature.

8 Maintenance

8.1 Safety

Electrical System

WARNING

Danger of injury from electrical shock!

A life threatening shock may result when the housing is open during operation.

- ▶ Only qualified personnel should open the housing.
- ▶ Disconnect the device from the electrical power supply before opening the device. Use a voltmeter to verify that the device is not under power!
- ▶ Be sure that the power supply cannot be reconnected without notice.

Improperly Performed Maintenance

WARNING

Danger of injury due to improperly performed maintenance!

Improperly performed maintenance may lead to serious injury and significant material damage.

- ▶ Provide for sufficient mounting clearance before starting to work.
- ▶ Keep the assembly area tidy and clean! Loose components and tools lying around or on top of each other may lead to accidents.
- ▶ When reinstalling previously removed components, make sure that the components are mounted properly, all fixing elements are reinstalled, and all screws are tightened to torque.
- ▶ Before putting the device back into operation:
 - ⇒ Make sure that all maintenance work has been performed and completed following the instructions and information provided in this manual.
 - ⇒ Make sure that no persons are still in the danger zone of the device.
 - ⇒ Make sure that all covers and safety devices have been installed and function properly.



Securing to Prevent Restart

WARNING

Danger to life from an unauthorized restart!

In the event of an unauthorized restart of the power supply during maintenance, there is a danger of serious injuries or death for persons in the danger zone.

- ▶ The device has no main switch, therefore disconnect the power cord from the power socket before working on the system.



Moving Parts



CAUTION

Accident hazard from movement of mechanical parts!

The fingers or hand may be pinched due to movement of mechanical parts.

- ▶ Shut off the device before accessing it.

Environmental protection

Observe the following environmental protection instructions during maintenance work:

- In respect to all lubrication points supplied manually with lubricant, remove any escaping, used or surplus grease and dispose of in accordance with applicable local regulations.

8.2 Required Parts

The following spare parts can be ordered for the BCU I

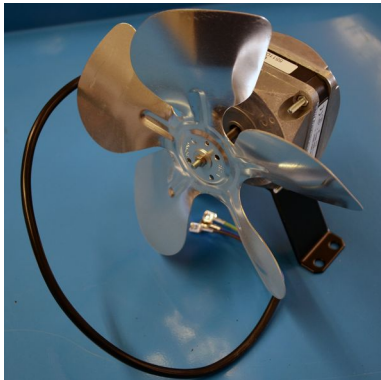

- Fan set 220-240V, 50Hz / 60Hz Z129903
- Fan set 100V / 50Hz or 100-115V / 60Hz Z129904



- Dust filter set BCU I Z150447

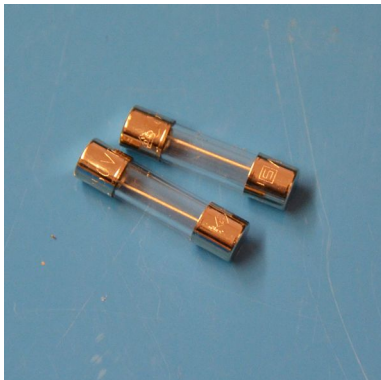

- IEC Standard Fuse 5 x 20mm, 10A T 1801424



- Butterfly nut M8 1803204



- O-ring 13.00X1.50 VITON green
1801892

8.3 Maintenance Work

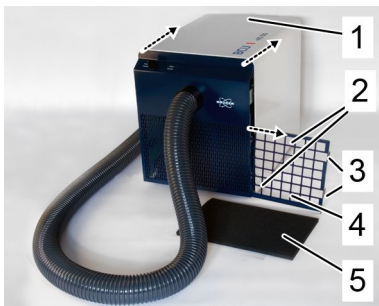

Figure 8.1: Replacing dust filter

1	Housing cover	4	Filter grid
2	Hexagon socket screws	5	Dust filter
3	Fasteners of filter grid		

The BCU I has a dust filter (Z150447). For optimal performance and maximum lifetime of the BCU I the dust filter has to be cleaned or replaced every 6 months.

Procedure to clean or replace the dust filter

1. Unplug the power cable from the power socket of the BCU I .
2. Loosen (but do not unscrew completely) the four hexagon socket screws (2).
3. Push the housing cover (1) back (approx. 30 – 40 mm).
4. Unlock the two fasteners (3) and remove the filter grid (4) with the dust filter (5).
5. Clean or replace the dust filter (5) with a vacuum cleaner.
6. Reinstall the dust filter (5).

9 Troubleshooting

Please refer to the table on the following page.

9.1 Problems & Solutions

No	Problem	Status LED	Remote LED	Cause	Solution
1	Low cooling power	Green flashing	irrelevant	<ul style="list-style-type: none"> BCU is in cool phase (normal state) 	Wait 15 min
2	Low cooling power	Green	irrelevant	<ul style="list-style-type: none"> Wrong Power Mode Insufficient or no VT gas (e.g. icing of the BCU due to high humidity in the VT gas) BCU failure 	<ul style="list-style-type: none"> Check / set chiller target power in edte to Power mode: strong Check CT gas flow (with BSVT: see TopSpin) and all connections and hoses. Check, maintain or install dryer (see Manual of the dryer) Service case: contact service
3	BCU is too cold / cannot reach high sample temperatures	Green	irrelevant	<ul style="list-style-type: none"> Not enough heater power Too high cooling power 	<ul style="list-style-type: none"> In the Configuration tab in edte, adjust the maximum heater power to a higher value. Remote: Reduce cooling power in edte Manual mode: Reduce cooling power by turning the rotary switch to a lower position (e.g. position 2 ->1)
4	BCU does not respond at all rotary switch positions	Off	Off	<ul style="list-style-type: none"> No electrical power or transport damage 	<ul style="list-style-type: none"> Connect the power cable to the power socket of the BCU. Check the power cable and the main fuse. Turn the main switch to position ON Check the fuse of the BCU I Service case: contact service.
5	BCU does not respond at all rotary switch positions	Red flashing	Red	<ul style="list-style-type: none"> BCU firmware is corrupt 	<ul style="list-style-type: none"> With BSVT: Download BCU firmware (again). With BVT: Service case, contact service.
6	BCU does not respond at all rotary switch positions	Red fast flashing	Off	<ul style="list-style-type: none"> BIS is corrupt 	<ul style="list-style-type: none"> Service case: contact service.

No	Problem	Status LED	Remote LED	Cause	Solution
7	BCU not visible in TopSpin in spite the BCU is connected with BSVT	irrelevant	Green	<ul style="list-style-type: none"> TopSpin failure 	<ul style="list-style-type: none"> Plug out and then plug in the communication cable. Reboot edte or TopSpin.
8	BCU not visible in TopSpin in spite the BCU is connected with BSVT	irrelevant	Off	<ul style="list-style-type: none"> Communication cable broken 	<ul style="list-style-type: none"> Exchange the communication cable (Z117511).
9	BCU does not respond to command of TopSpin	irrelevant	Green	<ul style="list-style-type: none"> Rotary switch in a manual mode 	<ul style="list-style-type: none"> Turn rotary switch to position remote.
10	BCU does not start in spite rotary switch is on remote and sample heater is on (BVT)	Off	Red	<ul style="list-style-type: none"> No switch signal (5V) from the BVT 	<ul style="list-style-type: none"> Plug in the communication cable from the BVT into the D-Sub 15 socket of the BCU. Exchange the communication cable (Z118350)
11	BCU shuts off after some time of operation	Red	irrelevant	<ul style="list-style-type: none"> BCU overheats 	<ul style="list-style-type: none"> Check the wall clearance (min 30 cm) to the inlet and / or outlet grid of the BCU. Clean the dust filter inside the BCU (see Maintenance) Check if the fan is working -> Repair kit for the BCU I: Z129903 (230 V). Z129904 (115 V). Service case: contact service.
12	Noise and / or vibrations from BCU	irrelevant	irrelevant	<ul style="list-style-type: none"> Transport lock has not been removed. Fan defective (BCU I) Transport damage 	<ul style="list-style-type: none"> Unscrew and remove transport lock. Repair kit for BCU I: Z129903 (230 V). Z129904 (115 V). Service case: contact service.

10 Replacement of Parts



Only trained Bruker personnel are allowed to install, mount, retrofit, repair, adjust and dismantle the unit!

10.1 Returning the Unit for Repair

If the Bruker Hotline diagnoses an instrument failure that requires a part to be returned for repair, please follow the procedure listed here:

1. Contact your local Bruker office to start the repair process (see Contact). Repair is always handled by your local Bruker office. Their reply will contain all necessary information for the subsequent repair process steps.
2. They will provide you with details on the shipping address, and also in most cases a “Return Merchandise Authorization” number (RMA number) that allows references to the repair case. Always refer to this RMA number in case of questions.
3. Send the defective part to the local Bruker office and include the following documents:
 - RMA sheet (if RMA number was assigned).
 - Signed Equipment Clearance Form. The Equipment Clearance Form will be sent to you as part of step 1 (see above) with information about the returned part (part number, serial number, your contact details) already filled in.
4. Attach the relevant papers to the *outside* of the packaging, for instance in a transparent polybag.



The unit should be returned using the original container and packing assembly. If this packaging is no longer available, contact your local Bruker office for further instructions.

11 Dismantling and Disposal

Following the end of its operational life, the device must be dismantled and disposed of in accordance with the environmental regulations.



Installation, initial commissioning, retrofitting, repairs, adjustments or dismantling of the device must only be carried out by Bruker Service or personnel authorized by Bruker. Damage due to servicing that is not authorized by Bruker is not covered by your warranty.

11.1 Dismantling

Before starting dismantling:

1. Shut down the device and secure to prevent restarting.
2. Disconnect the power supply from the device; discharge stored residual energy.
3. Remove consumables, auxiliary materials and other processing materials and dispose of in accordance with the environmental regulations.
4. Clean assemblies and parts properly and dismantle in compliance with applicable local occupational safety and environmental protection regulations.

11.2 Disposal Europe

Environmental information for laboratory and industrial customers within the EU (European Union)

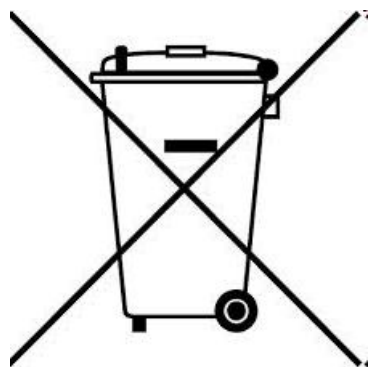

This laboratory product is developed and marketed for Business-to-Business (B2B), so does not fall under article 6 clause 3 of the German Act ElectroG. To meet the demands of the European Directive 2012/19/EU WEEE 2 (Waste of Electrical and Electronic Equipment) and the national Equipment Safety Act, electrical and electronic equipment that is marked with this symbol directly on or with the equipment and/or its packaging must not be disposed of together with unsorted municipal waste or at local municipal waste collecting points. The symbol indicates that the equipment should be disposed of separately from regular industrial/domestic waste.

Correct disposal and recycling will help prevent potential negative consequences for the environment and risk to personal health. It is your responsibility to dispose of this equipment using only legally prescribed methods of disposal and at collection points defined by government or local authorities in your area.

The WEEE register number can be found on the product label of the equipment. If you need further information on the disposal of equipment or collection and recovery programs available, contact your local Bruker BioSpin sales representative. Local authorities or professional waste management companies may also provide information on specific waste disposal services available in your area.

Disposal - End of Life (EoL) information: the common procedure as defined in the sales contract with Bruker BioSpin

After the lifespan of an electrical and electronic product, Bruker BioSpin takes responsibility for final disassembly and correct disposal in accordance with the European directive 2012/19/EU WEEE 2.

Bruker BioSpin offers to take back the equipment (only for deliveries after 23.03.2006) after termination of use at the customer site upon request by the customer. This request must be affirmed when the equipment is ordered from Bruker BioSpin. Additional costs for dismantling and transport service will apply!

Only 100% pre-decontaminated equipment can and will be accepted by Bruker BioSpin. A release document for decontamination can be inquired from your nearest Bruker BioSpin contact site, also to be used when repairs, going back to Bruker sites, are requested.

In compliance with WEEE II directive: **2012/19/EU**

11.3 Disposal USA and Other Countries

Disposal of these materials may be regulated due to environmental considerations. For disposal or recycling information, please contact our local office or your local authorities, or in the U.S.A., contact the Electronics Industry Alliance web site at www.eiae.org.

12 Contact

NMR Hotlines

Bruker Corporation provides dedicated hotlines and service centers. Please select the NMR service center or hotline you wish to contact from our list available at:

<https://www.bruker.com/service/information-communication/helpdesk.html>

Contact our NMR service centers, so that our specialists can respond as quickly as possible to all your service requests, application questions, software or technical needs.

CryoProbe Sales

BRUKER BioSpin AG
Industriestrasse 26
CH-8117 Fällanden
Switzerland
phone: + 41 44 825 91 11

email: info.bbio.ch@bruker.com
email: sales.bbio.ch@bruker.com
<http://www.bruker.com>

BRUKER Instruments, Inc.
44 Manning Road
Billerica, MA 01821
U.S.A.
phone: ++1-978-667-9580
fax: ++1-978-667-0985

email: sales.bbio.us@bruker.com
<http://www.bruker.com>

CryoProbe Service

BRUKER BioSpin AG
Service Department
Industriestrasse 26
CH-8117 Fällanden
Switzerland
phone: + 41 44 825 97 97

email: cryoprobe.service.ch@bruker.com
<http://www.bruker.com>
WEEE DE43181702

BRUKER Instruments, Inc.
44 Manning Road
Billerica, MA 01821
U.S.A.
phone: ++1-978-667-9580
fax: ++1-978-667-0985

email: cryoprobe.service.us@bruker.com
<http://www.bruker.com>





Bruker Corporation

info@bruker.com
www.bruker.com

Order No: Z33119